

# JVC



**CD RECEIVER**

**KD-LX100**

ENGLISH

**RECEPTOR CON CD**

**KD-LX100**

ESPAÑOL

**RECEPTEUR CD**

**KD-LX100**

FRANÇAIS

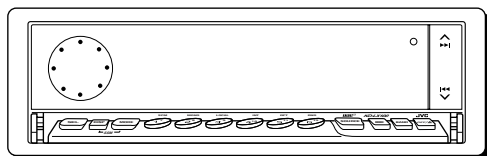
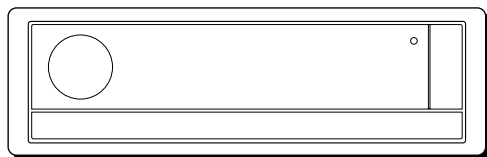

**BBE<sup>II</sup>**

For installation and connections, refer to the separate manual.  
Para la instalación y las conexiones, refiérase al manual separado.  
Pour l'installation et les raccordements, se référer au manuel séparé.

## **INSTRUCTIONS**

**MANUAL DE INSTRUCCIONES**  
**MANUEL D'INSTRUCTIONS**

**For customer Use:**

Enter below the Model No. and Serial No. which are located on the top or bottom of the cabinet. Retain this information for future reference.

Model No. \_\_\_\_\_

Serial No. \_\_\_\_\_

PIM163600

[J]

**INFORMATION (For U.S.A.)**

This equipment has been tested and found to comply with the limits for a Class B digital device, pursuant to Part 15 of the FCC Rules. These limits are designed to provide reasonable protection against harmful interference in a residential installation. This equipment generates, uses, and can radiate radio frequency energy and, if not installed and used in accordance with the instructions, may cause harmful interference to radio communications. However, there is no guarantee that interference will not occur in a particular installation. If this equipment does cause harmful interference to radio or television reception, which can be determined by turning the equipment off and on, the user is encouraged to try to correct the interference by one or more of the following measures:

- Reorient or relocate the receiving antenna.
- Increase the separation between the equipment and receiver.
- Connect the equipment into an outlet on a circuit different from that to which the receiver is connected.
- Consult the dealer or an experienced radio/TV technician for help.

**IMPORTANT FOR LASER PRODUCTS****Precautions:**

1. CLASS 1 LASER PRODUCT
2. **DANGER:** Invisible laser radiation when open and interlock failed or defeated. Avoid direct exposure to beam.
3. **CAUTION:** Do not open the top cover. There are no user-serviceable parts inside. Leave all servicing to qualified service personnel.
4. **CAUTION:** This CD player uses invisible laser radiation, however, is equipped with safety switches to prevent radiation emission when unloading CDs. It is dangerous to defeat the safety switches.
5. **CAUTION:** Use of controls, adjustments or performance of procedures other than those specified herein may result in hazardous radiation exposure.

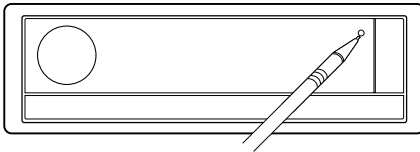
**How to reset your unit**

Press the reset button on the front panel using a ball-point pen or a similar tool. This will reset the built-in microcomputer.

**Note:**

*Your preset adjustments — such as preset channels or sound adjustments — will also be erased.*

**CAUTION on Volume Setting**

*CDs produce very little noise compared with other sources. If the volume level is adjusted for the tuner; for example, the speakers may be damaged by the sudden increase in the output level. Therefore, lower the volume before playing a disc and adjust it as required during playback.*

Thank you for purchasing a JVC product. Please read all instructions carefully before operation, to ensure your complete understanding and to obtain the best possible performance from the unit.

# CONTENTS

<b>LOCATION OF THE BUTTONS</b> .....	<b>4</b>	<b>OTHER MAIN FUNCTIONS</b> .....	<b>17</b>
Control panel .....	4	Setting the clock .....	17
Remote controller .....	5	Changing the general settings (PSM) .....	17
Preparing the remote controller .....	6	Controlling the volume automatically (Audio Cruise) .....	20
<b>BASIC OPERATIONS</b> .....	<b>7</b>	Assigning names to the sources .....	22
<b>RADIO BASIC OPERATIONS</b> .....	<b>8</b>	<b>CD CHANGER OPERATIONS</b> .....	<b>23</b>
Listening to the radio .....	8	Playing CDs .....	23
Storing stations in memory .....	9	Selecting CD playback modes .....	24
Tuning into a preset station .....	10	<b>EXTERNAL COMPONENT OPERATIONS</b> ...	<b>26</b>
<b>CD OPERATIONS</b> .....	<b>11</b>	Playing an external component .....	26
Playing a CD .....	11	<b>TROUBLESHOOTING</b> .....	<b>27</b>
Locating a track or a particular portion on a CD .....	12	<b>MAINTENANCE</b> .....	<b>28</b>
Selecting CD playback modes .....	12	Handling CDs .....	28
Prohibiting CD ejection .....	13	<b>SPECIFICATIONS</b> .....	<b>29</b>
Playing a CD Text .....	13		
<b>SOUND ADJUSTMENTS</b> .....	<b>14</b>		
Adjusting the sound .....	14		
Turning on/off the BBE <sup>II</sup> function .....	15		
Using the sound control memory .....	15		
Storing your own sound adjustments .....	16		

## About the demonstration mode (DEMO MODE)...

When shipped from the factory, "DEMO MODE" is set to "DEMO ON" in this unit. The demonstration will start automatically if no sound comes in for 3 minutes. (See page 20.)

### To activate the display demonstration manually

While holding DISP, press **▲ ►►** until "DEMO" appears on the display.

Various functions and display illumination modes equipped with this unit will be demonstrated repeatedly in sequence. During the display demonstration, "DEMO" flashes on the display.

To turn off the display demonstration, press **▲ ►►** again for a few seconds while holding DISP.

- The display demonstration will turn off automatically after about 1 hour.

## BEFORE USE

### \*For safety....

- Do not raise the volume level too much, as this will block outside sounds, making driving dangerous.
- Stop the car before performing any complicated operations.

### \*Temperature inside the car....

If you have parked the car for a long time in hot or cold weather, wait until the temperature in the car becomes normal before operating the unit.



# LOCATION OF THE BUTTONS

ENGLISH

## Control panel

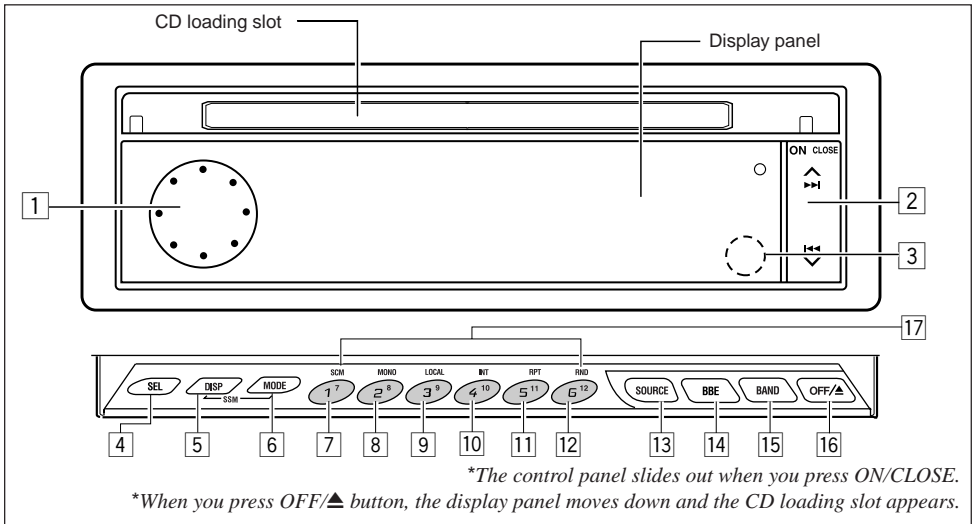

- |   |   |
|---|---|
| <p>1 Control dial</p> <p>2 ▲▶▶/ ◀◀▼ button</p> <ul style="list-style-type: none"> <li>• ▲▶▶/ ◀◀▼ also functions as ON or CLOSE button.</li> </ul> <p>3 Remote sensor</p> <p>4 SEL (select) button</p> <p>5 DISP (display) button</p> <ul style="list-style-type: none"> <li>• Also functions as SSM buttons when pressed together with the MODE button.</li> </ul> <p>6 MODE button</p> <ul style="list-style-type: none"> <li>• Also functions as SSM buttons when pressed together with the DISP button.</li> </ul> | <p>7 SCM (sound control memory) button</p> <p>8 MONO button</p> <p>9 LOCAL button</p> <p>10 INT (intro) button</p> <p>11 RPT (repeat) button</p> <p>12 RND (random) button</p> <p>13 SOURCE button</p> <p>14 BBE button</p> <p>15 BAND button</p> <p>16 OFF/▲ (eject) button</p> <p>17 Number buttons</p> |
|---|---|

### How to use the number buttons:

After pressing MODE, the number buttons work as different function buttons (while "MODE" remains on the display).

**To use these buttons as number buttons after pressing MODE**, wait for 5 seconds without pressing any number button so that "MODE" disappears from the display.

- Pressing MODE again also erases "MODE" from the display.

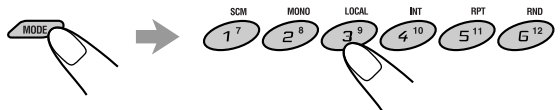



## Remote controller

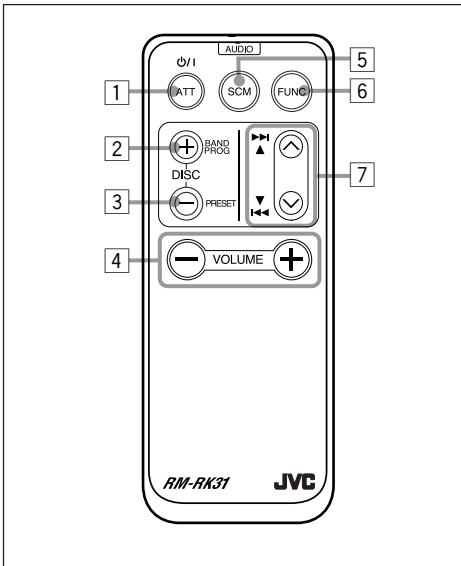

- 1 • Turns on the unit if pressed when the unit is turned off.
  - Turns off the unit if pressed and held until “SEE YOU” appears on the display.
  - Drops the volume level for a moment if pressed briefly.  
Press again to resume the volume.
- 2 • Functions as the BAND button while listening to the radio.  
Each time you press the button, the band changes.
- Functions as the DISC + button while listening to the CD changer.  
Each time you press the button, the disc number increases, and the selected disc starts playing.
- Does not function as the PROG button.

- 3 • Functions as the PRESET button while listening to the radio.  
Each time you press the button, the preset station number increases, and the selected station is tuned in.
- Functions as the DISC – button while listening to the CD changer.  
Each time you press the button, the disc number decreases, and the selected disc starts playing.
- 4 Functions the same as the control dial on the main unit.  
**NOTE:** *This button does not function for the preferred setting mode adjustment.*
- 5 Selects the sound mode.  
Each time you press SCM (Sound Control Memory), the mode changes.
- 6 Selects the source.  
Each time you press FUNC (function), the source changes.
- 7 • Searches stations while listening to the radio.
  - Fast-forwards or reverses the track if pressed and held while listening to a CD.
  - Skips to the beginning of the next track or goes back to the beginning of the current (or previous) track if pressed briefly while listening to a CD.



## Preparing the remote controller

Before using the remote controller:

- Aim the remote controller directly at the remote sensor on the main unit. Make sure there is no obstacle in between.

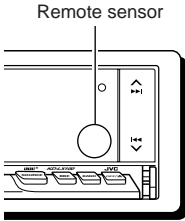

- Do not expose the remote sensor to strong light (direct sunlight or artificial lighting).

### Installing the battery

When the controllable range or effectiveness of the remote controller decreases, replace the battery.

#### 1. Remove the battery holder.

- 1) Push out the battery holder in the direction indicated by the arrow using a ball-point pen or a similar tool.
- 2) Remove the battery holder.

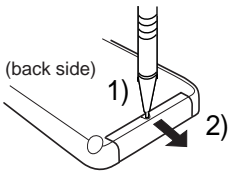

#### 2. Place the battery.

Slide the battery into the holder with the + side facing upwards so that the battery is fixed in the holder.

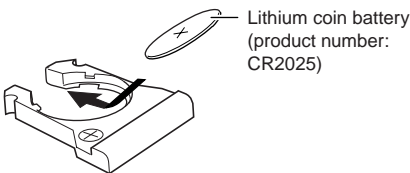

Lithium coin battery  
(product number:  
CR2025)

#### 3. Return the battery holder.

Insert again the battery holder pushing it until you hear a clicking sound.

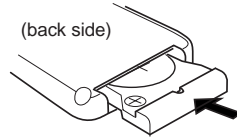

#### WARNING:

- Store the batteries in a place which children cannot reach.  
*If a child accidentally swallows the batteries, immediately consult a doctor.*
- Do not recharge, short, disassemble or heat the batteries or dispose of in a fire.  
*Doing any of these things may cause the batteries to give off heat, crack or start a fire.*
- Do not leave the batteries with other metallic materials.  
*Doing this may cause the batteries to give off heat, crack or start a fire.*
- When throwing away or saving batteries, wrap in tape and insulate; otherwise, it may cause the batteries to give off heat, crack or start a fire.
- Do not poke the batteries with tweezers or similar tools.  
*Doing this may cause the batteries to give off heat, crack or start a fire.*

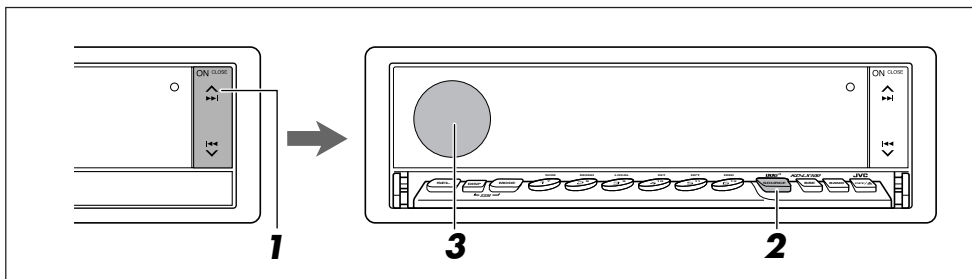

## 1 Turn on the power.

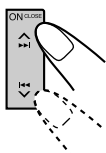

The display illuminates and the control panel and control dial come out.

## 3 Adjust the volume.

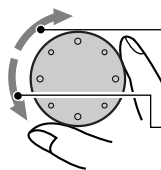

To increase the volume.

To decrease the volume.

## 2 Select the source.



Each time you press the button, the source changes as follows:

- Tuner (FM or AM) → CD\*
- CD changer or external component\*\*
- (back to the beginning)

\* If a CD is not in the loading slot, you cannot select CD as the source to play.

\*\* Without connecting the equipment and setting "EXT INPUT" correctly (see page 20), you cannot select it as the source to play.

To operate the tuner (FM or AM), see pages 8 – 10.

To operate the CD player, see pages 11 – 13.

To operate the CD changer, see pages 23 – 25.

To operate the external component, see page 26.



Volume level meter

## 4 Adjust the sound as you want (see page 14).

### To drop the volume in a moment

Press SOURCE for more than 1 second while listening to any source. "ATT" starts flashing on the display, and the volume level will drop in a moment. To resume the previous volume level, press the button for more than 1 second again.

### To turn off the power

Press and hold OFF/▲ until "SEE YOU" appears on the display.

#### Note:

When you use this unit for the first time, set the built-in clock correctly, see page 17.

#### Note on display illustrations:

Illustrations will differ from what appears if "CLOCK DISP" is set to "CLOCK OFF." See page 19.

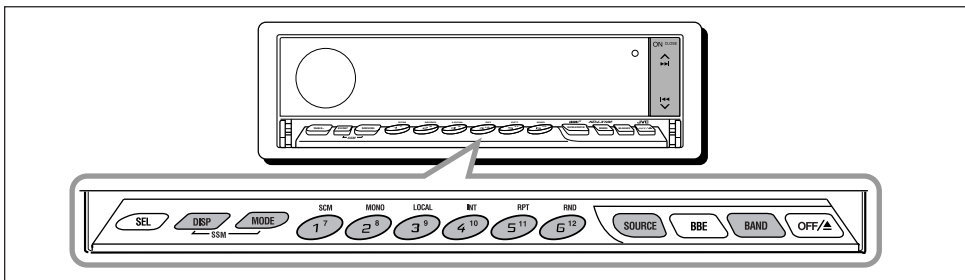

## Listening to the radio

You can use either automatic searching or manual searching to tune into a particular station.

### Searching a station automatically: Auto search

#### 1 Select the band.

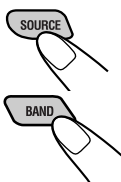

- 1 Press SOURCE to select tuner as the source.
- 2 If necessary, press BAND repeatedly to select the band.

Each time you press the button, the band changes as follows:

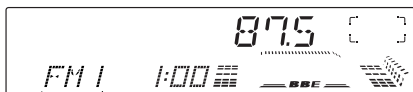
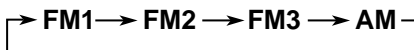

Selected band appears.

**Note:**

This receiver has three FM bands (FM1, FM2, FM3). You can use any one of them to listen to an FM broadcast.

#### 2 Start searching a station.

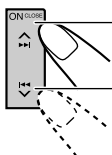

- Press ▲▶▶ to search stations of higher frequencies.
- Press ◀◀▼ to search stations of lower frequencies.

When a station is received, searching stops.

To stop searching before a station is received, press the same button you have pressed for searching.

### To tune in FM stations only with strong signals

- 1 Press MODE. "MODE" appears on the display, and the number buttons can work as different function buttons.
- 2 Press LOCAL, while "MODE" is still on the display, so that the LOCAL indicator lights up on the display. This function works only while searching FM stations, including SSM preset (see page 9). Each time you press the button, the LOCAL indicator lights up and goes off alternately.

### Searching a station manually: Manual search

#### 1 Select the band.

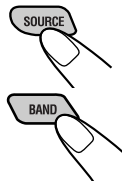

- 1 Press SOURCE to select tuner as the source.
- 2 If necessary, press BAND repeatedly to select the band.

Each time you press the button, the band changes as follows:

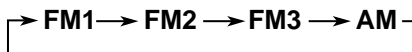

**Note:**

This receiver has three FM bands (FM1, FM2, FM3). You can use any one of them to listen to an FM broadcast.



**2** Press and hold **▲▶▶|** or **|◀◀▼** until **"M"** (manual) starts flashing on the display.

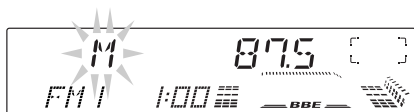

**3** Tune into a station you want while **"M"** is flashing.

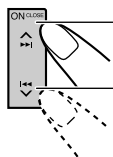

Press **▲▶▶|** to tune into stations of higher frequencies.

Press **|◀◀▼** to tune into stations of lower frequencies.

- If you release your finger from the button, the manual mode will automatically turn off after 5 seconds.
- If you hold down the button, the frequency keeps changing until you release the button.

## Storing stations in memory

You can use one of the following two methods to store broadcasting stations in memory.

- Automatic preset of FM stations: SSM (Strong-station Sequential Memory)
- Manual preset of both FM and AM stations

### FM station automatic preset: SSM

You can preset 6 local FM stations in each FM band (FM1, FM2 and FM3).

**1** Select the FM band (FM1–3) you want to store FM stations into.

- 1 Press **SOURCE** to select tuner as the source.
- 2 If necessary, press **BAND** repeatedly to select the band.

Each time you press the button, the band changes as follows:

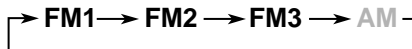

**2** Press and hold both buttons for more than 2 seconds.

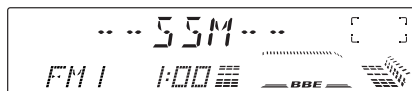
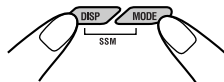

"SSM" appears, then disappears when automatic preset is over.

Local FM stations with the strongest signals are searched and stored automatically in the band number you have selected (FM1, FM2 or FM3). These stations are preset in the number buttons — No.1 (lowest frequency) to No.6 (highest frequency).

When automatic preset is over, the station stored in number button 1 will be automatically tuned in.

### When an FM stereo broadcast is hard to receive:

**1** Press **MODE** while listening to an FM stereo broadcast (the **ST** indicator lights up while receiving an FM stereo broadcast).

**2** Press **MONO**, while **"MODE"** is still on the display, so that the **MO** indicator lights up on the display. The sound you hear becomes monaural but the reception will be improved (the **ST** indicator goes off).

Each time you press the button, the **MO** indicator lights up and goes off alternately.



## Manual preset

You can preset up to 6 stations in each band (FM1, FM2, FM3 and AM) manually.

Ex: Storing an FM station of 88.3 MHz into the preset number 1 of the FM1 band

### 1 Select the band (FM1).

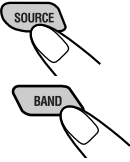

- 1 Press SOURCE to select the tuner as the source.
- 2 Press BAND repeatedly to select the FM1 band.

### 2 Tune into a station of 88.3 MHz.

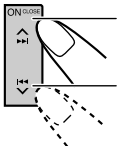

- Press  $\blacktriangle \triangleright \triangleright$  to tune into stations of higher frequencies.
- Press  $\blacktriangleleft \triangleleft \blacktriangledown$  to tune into stations of lower frequencies.



### 3 Press and hold the number button (in this example, 1) for more than 2 seconds.

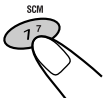

Band number and "MEMO" appear alternately for a while.

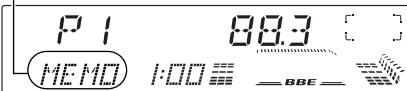

### 4 Repeat the above procedure to store other stations into other preset numbers.

#### Notes:

- A previously preset station is erased when a new station is stored in the same preset number.
- Preset stations are erased when the power supply to the memory circuit is interrupted (for example, during battery replacement). If this occurs, preset the stations again.

## Tuning into a preset station

You can easily tune into a preset station. Remember that you must store stations first. If you have not stored them yet, see "Storing stations in memory" on pages 9 and 10.

### 1 Select the band.

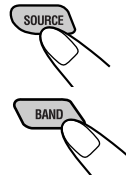

- 1 Press SOURCE to select tuner as the source.
- 2 If necessary, press BAND repeatedly to select the band.

Each time you press the button, the band changes as follows:

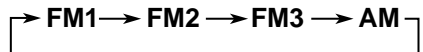

### 2 Select the number (1 – 6) for the preset station you want.

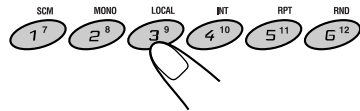

#### When using this unit in an area other than North or South America:

You need to change the AM/FM channel intervals. See "To change the AM/FM channel intervals – AREA" on page 19.

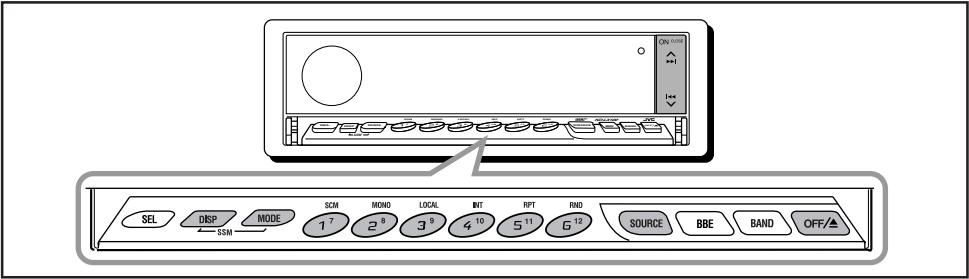

## Playing a CD

### 1 Open the loading slot.

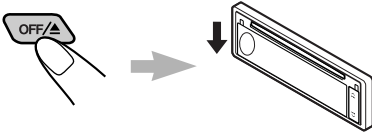

The display panel moves down, and the loading slot appears.

### 2 Insert a disc into the loading slot.

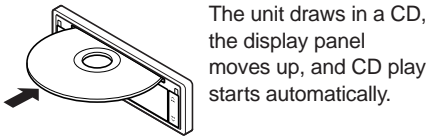

The unit draws in a CD, the display panel moves up, and CD play starts automatically.



The CD indicator lights up.

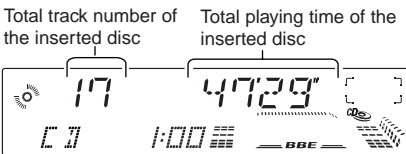

Total track number of the inserted disc

Total playing time of the inserted disc

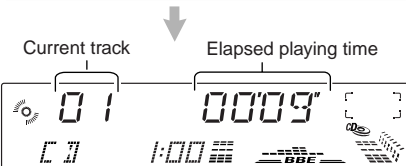

Current track

Elapsed playing time

### Notes:

- When a CD is in the loading slot, selecting “CD” as the source by pressing SOURCE starts CD play.
- When a CD is inserted upside down, the CD automatically ejects. (“CD EJECT” appears on the display.)
- When you play a CD Text, the disc title and performer appear on the display. Then the current track title appears on the display, followed by the track number and elapsed playing time. See also “Playing a CD Text” (page 13) and “To select the scroll mode – SCROLL” (page 19). If a CD Text includes much text information, some may not appear on the display.
- If you change the source, CD play also stops (without ejecting the CD).

### To stop play and eject the CD

Press OFF/▲ briefly.

CD play stops, the display panel moves down, then the CD automatically ejects from the loading slot.

To move up the display panel, press ▲▶▶ or ◀◀▼. If no button is pressed, the display panel will move up in about 5 minutes.

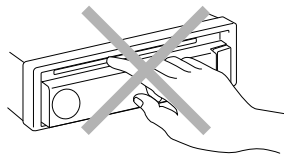

**CAUTION:** NEVER insert your finger between the display panel and the unit, as it may get caught in the unit.

### Note:

If the ejected disc is not removed for about 15 seconds, the disc is automatically inserted again into the loading slot to protect it from dust. (CD play will not start this time.)



## Locating a track or a particular portion on a CD

### To fast-forward or reverse the track

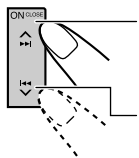

Press and hold **FF**, while playing a CD, to fast-forward the track.

Press and hold **RR**, while playing a CD, to reverse the track.

### To go to the next tracks or the previous tracks

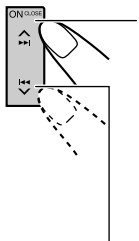

Press **N** briefly, while playing a CD, to go ahead to the beginning of the next track. Each time you press the button consecutively, the beginning of the next tracks is located and played back.

Press **P** briefly, while playing a CD, to go back to the beginning of the current track. Each time you press the button consecutively, the beginning of the previous tracks is located and played back.

### To go to a particular track directly

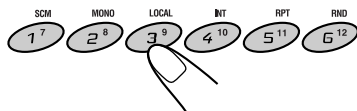

Press the number button corresponding to the track number to start its playback.

- To select a track number from 1 – 6:  
Press 1 (7) – 6 (12) briefly.
- To select a track number from 7 – 12:  
Press and hold 1 (7) – 6 (12) for more than 1 second.

## Selecting CD playback modes

### To play back tracks at random (Random Play)

You can play back all tracks on the CD at random.

- 1 Press MODE while playing a CD. "MODE" appears on the lower part of the display, and the number buttons can work as different function buttons.
- 2 Press RND (Random), while "MODE" is still on the display, so that the RND indicator lights up on the display. Each time you press the button, CD random play mode turns on and off alternately.



When the random mode is turned on, the RND indicator lights up on the display and a track randomly selected starts playing.

### To play back tracks repeatedly (Repeat Play)

You can play back the current track repeatedly.

- 1 Press MODE while playing a CD. "MODE" appears on the lower part of the display, and the number buttons can work as different function buttons.
- 2 Press RPT (Repeat), while "MODE" is still on the display, so that the RPT indicator lights up on the display. Each time you press the button, CD repeat play mode turns on and off alternately.

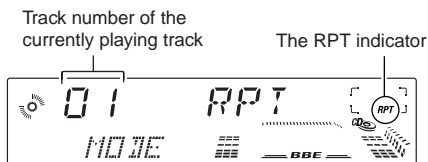

When the repeat mode is turned on, the RPT indicator lights up on the display.



## To play back only intros (Intro Scan)

You can play back the first 15 seconds of each track sequentially.

- 1 Press MODE while playing a CD.  
"MODE" appears on the lower part of the display, and the number buttons can work as different function buttons.
- 2 Press INT (Intro), while "MODE" is still on the display.

Each time you press the button, CD intro scan mode turns on and off alternately.

Track number of the currently playing track

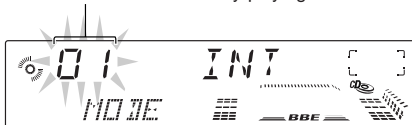

When the intro scan mode is turned on, "INT" appears on the display for 5 seconds and the track number flashes.

## Prohibiting CD ejection

You can prohibit CD ejection and can lock a CD in the loading slot.

While pressing SOURCE, press and hold OFF/▲ for more than 2 seconds.

"NO EJECT" flashes on the display for about 5 seconds, and the CD is locked and cannot be ejected.



### Note:

If you press OFF/▲ while CD ejection is prohibited, the control panel moves down, but the CD cannot be ejected. ("NO EJECT" appears on the display.)

To move up the display panel, press ▲ ►► or ◀◀ ▼.

To cancel the prohibition and unlock the CD, press and hold OFF/▲ for more than 2 seconds again, while pressing SOURCE.

"EJECT OK" flashes on the display for about 5 seconds, and the CD is unlocked.



## Playing a CD Text

In a CD Text, some information about the disc (its disc title, performer and track title) is recorded. You can show these disc information on the display.

### Select text display mode while playing a CD Text.



Each time you press the button, the display changes as follows:

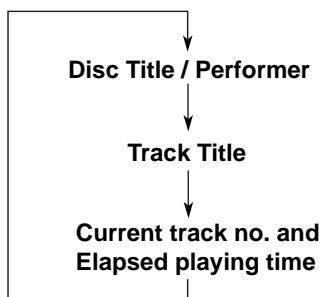

### Notes:

- The display shows up to 10 characters at one time and scrolls if there are more than 10 characters. See also "To select the scroll mode – SCROLL" on page 19.
- When you press DISP while playing a conventional CD, "NO NAME" appears for the disc title/performer and the track title.



# SOUND ADJUSTMENTS

ENGLISH

## Adjusting the sound

You can adjust the sound characteristics to your preference.

### 1 Select the item you want to adjust.

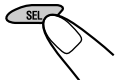

Each time you press the button, the adjustable items change as follows:

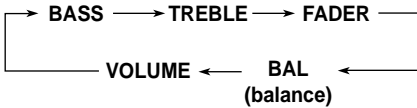

### 2 Adjust the level.

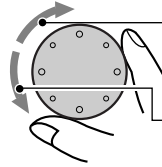

To increase the level.

To decrease the level.



Equalization pattern changes as you adjust the bass or treble.

#### Note:

Normally the control dial works for volume adjustment. So you do not have to select "VOLUME" to adjust the volume level.

Indication	To do:	Range
BASS	Adjust the bass.	-06 (min.)   +06 (max.)
TREBLE	Adjust the treble.	-06 (min.)   +06 (max.)
FADER*	Adjust the front and rear speaker balance.	R06 (Rear only)   F06 (Front only)
BAL (balance)	Adjust the left and right speaker balance.	L06 (Left only)   R06 (Right only)
VOLUME	Adjust the volume.	00 (min.)   50 (max.)

\* If you are using a two-speaker system, set the fader level to "00."



## Turning on/off the BBE<sup>II</sup> function

The BBE<sup>II</sup>\* function restores the brilliance and clarity of the original live sound in recording, broadcasts, etc.

When a speaker reproduces sound, it introduces frequency-dependent phase shifting, causing high-frequency sounds to take longer to reach the ear than low frequency sounds. The BBE<sup>II</sup> function adjusts the phase relationship between the low, mid and high frequencies by adding a progressively longer delay time to the low and mid frequencies, so that all frequencies reach the listener's ears at the proper time.

In addition, the BBE<sup>II</sup> function boosts low and high frequencies, which loudspeakers tend to be less efficient in reproducing, through dynamic, program-driven augmentation. When combined with the phase compensation feature, the resulting sound has a clearer, more finely detailed "live" presence.

Each time you press BBE, the BBE<sup>II</sup> function changes as follows:

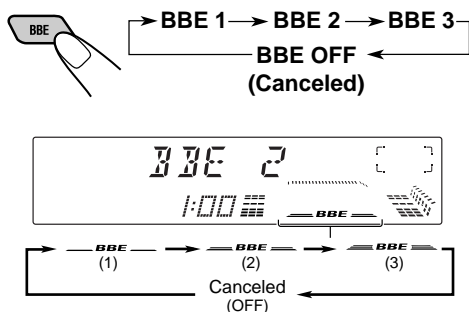

As the number gets higher, the BBE<sup>II</sup> function becomes stronger.

When shipped from the factory, the BBE<sup>II</sup> function is set to "BBE 2."

**To cancel the BBE<sup>II</sup> function,** select "BBE OFF."

\* Under license from BBE Sound, Inc.

**BBE<sup>II</sup>** is a trademark of BBE Sound, Inc.

## Using the sound control memory

You can select and store a preset sound adjustment suitable for each playback source. (**Advanced SCM**)

### Selecting and storing the sound modes

Once you select a sound mode, it is stored in memory. It will be recalled every time you select the same source and will be shown on the display.

A sound mode can be stored for each of the following sources — FM1, FM2, FM3, AM, CD and external components.

- If you do not want to store the sound mode separately for each playback source, but want to use the same sound mode for all the sources, see "To cancel Advanced SCM – SCM LINK" on page 19.

#### 1 Press MODE.

The number buttons can work as different function buttons.

**Within 5 seconds**

#### 2 Select the sound mode you want.

Each time you press the button, the sound mode changes as follows:

SCM BEAT → SCM SOFT  
SCM OFF ← SCM POP

- When "SCM LINK" is set to "LINK ON," the selected sound mode can be stored in memory for the current source and the effect applies only to the current source. Each time you change the playback source, the SCM indicator flashes on the display.
- When "SCM LINK" is set to "LINK OFF," the selected sound mode effect applies to any source.

CONTINUED ON THE NEXT PAGE



Indication	For:	Preset values		
		Bass	Treble	BBE <sup>II</sup>
SCM BEAT	Rock or disco music	+02	00	2
SCM SOFT	Quiet background music	+01	-03	OFF
SCM POP	Light music	+04	+01	OFF
SCM OFF	(Flat sound)	00	00	2

### Recalling the sound modes

When “SCM LINK” is set to “LINK ON,” select the source.



The sound mode stored in memory for the selected source is recalled.



#### Notes:

- You can adjust each sound mode to your preference, and store it in memory. If you want to adjust and store your original sound mode, see “Storing your own sound adjustments” below.
- To adjust the bass and treble reinforcement levels or to turn on/off the BBE<sup>II</sup> function temporarily, see pages 14 and 15. (Your adjustments will be canceled if another source is selected.)

### Storing your own sound adjustments

You can adjust the sound modes (SCM BEAT, SCM SOFT, SCM POP) to your preference and store your own adjustments in memory.

- There is a time limit in doing the following procedure. If the setting is canceled before you finish, start from step 1 again.

### 1 Press MODE.

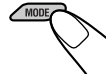

The number buttons can work as different function buttons.



### 2 Select the sound mode you want.

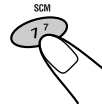

For details, see page 15.

### 3 1 Select the item you want to adjust (bass or treble).

#### 2 Adjust the selected item.

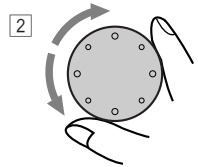
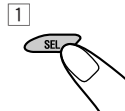

Repeat steps 3 to adjust the other items.

To adjust the BBE<sup>II</sup> level, see page 15.

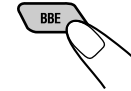

### 4 Press MODE.

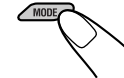

### 5 Press and hold SCM until the sound mode you have selected flashes on the display.

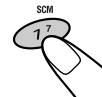

Your adjustment made for the selected sound mode is stored in memory.

### 6 Repeat the same procedure to adjust other sound modes.

#### To reset to the factory settings

Repeat the same procedure and reassign the preset values listed in the table on the left column.



## Setting the clock

- 1 Press and hold SEL (select) for more than 2 seconds so that one of the PSM items appears on the display. (See page 18.)



- 2 Set the hour.

- 1 Select "CLOCK HOUR" if not shown on the display.
- 2 Adjust the hour.

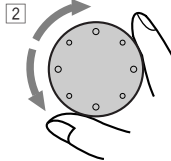
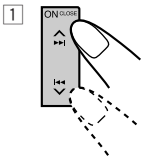

- 3 Set the minute.

- 1 Select "CLOCK MIN."
- 2 Adjust the minute.

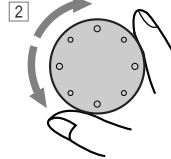
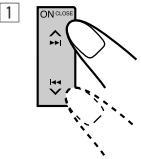

- 4 Press SEL (select) to finish the setting.



## Changing the general settings (PSM)

You can change the items listed on the next page by using the PSM (Preferred Setting Mode) control.

### Basic Procedure

- 1 Press and hold SEL (select) for more than 2 seconds so that one of the PSM items appears on the display. (See page 18.)

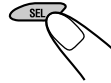

- 2 Select a PSM item you want to adjust. (See page 18.)

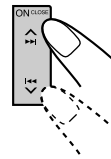

- 3 Adjust the PSM item selected above.

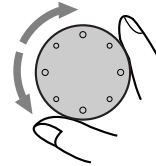

- 4 Repeat steps 2 and 3 to adjust the other PSM items if necessary.

- 5 Press SEL (select) to finish the setting.

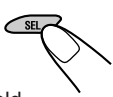
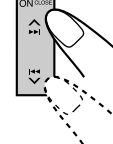
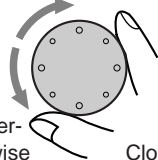

**Preferred Setting Mode (PSM) items**

		<b>1</b> 		<b>2</b> 		<b>3</b> 		Factory-preset settings	See page
		Hold.		Select.		Set. Counter-clockwise      Clockwise			
<b>CLOCK HOUR</b>	Hour adjustment	Back	Advance	1:00	17				
<b>CLOCK MIN</b>	Minute adjustment	Back	Advance						
<b>SCM LINK</b>	Sound control memory linkage	LINK OFF	LINK ON	LINK ON	19				
<b>CLOCK DISP</b>	Clock display	CLOCK OFF	CLOCK ON	CLOCK ON	19				
<b>LEVEL</b>	Level display	4 types (see page 19)		NORMAL	19				
<b>DIMMER</b>	Dimmer mode	AUTO ↕ ON	↔ OFF ↕	AUTO	19				
<b>CRUISE</b>	Audio cruise	CRUISE 1 ↔ CRUISE 2 ↕ CRUISE OFF ↕		CRUISE OFF	20				
<b>RPM SET*</b>	Idling speed	—		800 rpm	21				
<b>BOOST*</b>	Boost	BOOST 01 – 15		BOOST 05	21				
<b>BEEP SW</b>	Key-touch tone	BEEP OFF	BEEP ON	BEEP ON	19				
<b>SCROLL</b>	Scroll mode	ONCE ↕	↔ AUTO OFF ↕	ONCE	19				
<b>AREA</b>	Channel interval	AREA US	AREA EU	AREA US	19				
<b>EXT INPUT</b>	External component	CHANGER	LINE INPUT	CHANGER	20				
<b>FLAT PANEL</b>	Flat panel	FLAT OFF	FLAT ON	FLAT OFF	20				
<b>DEMO MODE</b>	Demo mode	DEMO OFF	DEMO ON	DEMO ON	20				

**4** Press SEL (select) to finish the setting.

\* When you select "CRUISE 1" or "CRUISE 2" for Audio Cruise Mode, you can adjust these items.

## To cancel Advanced SCM — SCM LINK

You can cancel the Advanced SCM (Sound Control Memory), and unlink the sound modes and the playback sources.

When shipped from the factory, a different sound mode can be stored in memory for each source so that you can change the sound modes simply by changing the sources.

- LINK ON: Advanced SCM (different sound modes for different sources)
- LINK OFF: Conventional SCM (one sound mode for all sources)

## To set the clock display — CLOCK DISP

You can set the clock to be shown on the lower part of the display when the unit is turned on. When shipped from the factory, the clock is set to be shown on the display.

- CLOCK ON: Clock display is turned on.
- CLOCK OFF: Clock display is turned off. When "CLOCK OFF" is selected, the current sound mode setting (see page 15) is shown on the upper part of the display\*.

*\* If an external source is selected, the current sound mode setting is shown on the lower part of the display.*

## To select the level meter — LEVEL

You can select the level meter display according to your preference. When shipped from the factory, "NORMAL" is selected.

- NORMAL: Normal audio level meter (illuminates from bottom to top).
- MIRROR: Volume level meter illuminates as if it were reflected on a mirror.
- LEVEL OFF: Level meter stays lit and does not change its illumination.
- ALL OFF: Level meter turns off.

## To select the dimmer mode — DIMMER

When you turn on the car headlights, the display automatically dims (Auto Dimmer).

When shipped from the factory, Auto Dimmer is activated.

- AUTO: Activates Auto Dimmer.
- OFF: Cancels Auto Dimmer.
- ON: Always dims the display.

### **Note on Auto Dimmer:**

*Auto Dimmer equipped with this unit may not work correctly on some vehicles, particularly on those having a control dial for dimming.*

*In this case, set the dimmer mode to "ON" or "OFF."*

## To turn on/off the key-touch tone — BEEP SW

You can deactivate the key-touch tone if you do not want it to beep each time you press a button. When shipped from the factory, the key-touch tone is activated.

- BEEP ON: Activates the key-touch tone.
- BEEP OFF: Deactivates the key-touch tone.

## To select the scroll mode — SCROLL

You can select the scroll mode for the disc information if it consists of more than 10 characters. When shipped from the factory, Auto Scroll mode is set to "ONCE."

- ONCE: Scrolls only once.
- AUTO: Repeats the scroll (in 5-second intervals).
- OFF: Cancels Auto Scroll.

### **Note:**

*Even if the scroll mode is set to "OFF," you can scroll the display by pressing DISP for more than 1 second.*

## To change the AM/FM channel intervals — AREA

When this unit is shipped from the factory, the channel intervals are set to 10 kHz for AM and 200 kHz for FM (AREA US settings).

You will have to change the channel intervals when using this unit in an area other than North America and South America.

- AREA EU: Select this when using this unit in an area other than North and South America. (9 kHz for AM and 50 kHz (for manual tuning) / 100 kHz (for searching) for FM)
- AREA US: Select this when using this unit in North or South America. (10 kHz for AM and 200 kHz for FM)

### **Note:**

*If the channel intervals settings are changed, the following will occur.*

- *The names assigned to the stations will be erased from memory. To reassign the names, see "Assigning names to the sources" on pages 22.*

## To select the external component to use — EXT INPUT

You can connect the external component to the CD changer jack on the rear using the Line Input Adaptor KS-U57 (not supplied).

To use the external component as the playback source through this unit, you need to select which component — CD changer or external component — to use. When shipped from the factory, “CHANGER” is selected as the external component.

- CHANGER: To use the CD changer.
- LINE INPUT: To use the external component other than the CD changer.

## To make the front panel look flat (hiding the control panel) — FLAT PANEL

When operating the receiver using the remote control, you can hide the control panel to make the front panel look flat. When shipped from the factory, “FLAT OFF” is selected.

- FLAT ON: The control panel will not come out when you turn on the unit.  
To use the control panel, press ◀◀ ▼ so that the control panel comes out. If no operation is done for about 10 seconds, it automatically goes back into the receiver.
- FLAT OFF: You can use the control panel normally.

**Note:**

When “FLAT ON” is selected, you can eject a CD by holding ▶◀◀ ▼.

## To turn the demo mode on or off — DEMO MODE

You can turn the demo mode on or off. When shipped from the factory, “DEMO ON” is selected.

- DEMO ON: Turns the demo mode on. The demonstration will start automatically if no sound comes in for 3 minutes.
- DEMO OFF: Turns the demo mode off.

**Note:**

If the unit has been reset (and the power is on), demonstration will start if no sound comes in for about 10 seconds.

## Controlling the volume automatically (Audio Cruise)

You can select the proper cruise mode for your car.

This unit changes the volume level automatically (at 3 possible levels) based on the driving speed of your car by detecting the alternator’s generating frequency (Audio Cruise).

If you want to use this mode, follow the procedure below. When shipped from the factory, this mode is set to “CRUISE OFF.”

- CRUISE 1: Select this if your car is relatively quiet.
- CRUISE 2: Select this if your car is relatively loud.  
The volume increase rate is twice as much as that of the CRUISE 1 setting.
- CRUISE OFF: Cancels Audio Cruise.

**1** Press and hold SEL (Select) for more than 2 seconds so that one of the PSM items appears on the display. (See page 18.)



**2** Select “CRUISE MODE.”

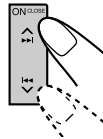

**3** Select the desired setting.

As you turn the control dial, the Audio Cruise mode changes as follows:

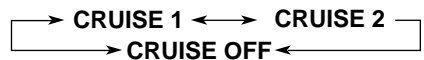
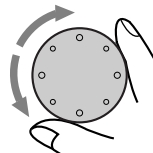

#### 4 Press SEL (select) to finish the setting.



When this function is turned on (the CRUISE indicator lights up on the display), the proper volume level is automatically selected among the 3 possible levels according to the driving speed, and the selected level is shown on the display.

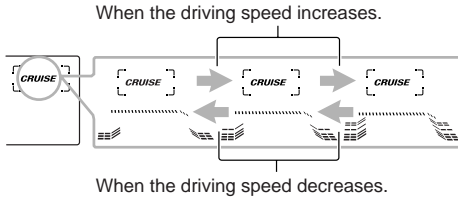

#### To adjust the volume increase rate

If you find Audio Cruise increases (or decreases) the volume either too much or too little as the driving speed changes, you can adjust the increase rate by changing the boost level. To change it, follow the procedure below.

- 1 Press and hold SEL (select) for more than 2 seconds so that one of the PSM items appears on the display.
- 2 Press ▲▶▶I or I◀◀▼ repeatedly until "CRUISE MODE" appears on the display.
- 3 Turn the control dial to select either "CRUISE 1" or "CRUISE 2."
- 4 Press ▲▶▶I (or I◀◀▼) to select "BOOST." The current boost level also appears on the display.
- 5 Turn the control dial to select the desired boost level (among 01 to 15).
- 6 Press SEL (select) to finish the setting.

#### If Audio Cruise does not function correctly

You may need to store the idling speed into memory to make Audio Cruise function correctly.

NOTICE that a number of factors, such as electric power steering, wipers, power windows, air conditioner, etc. do generate noises and, as a result, may cause Audio Cruise not to function correctly. If this is the main cause of malfunction, connect the memory backup lead (yellow lead) directly to the car battery to prevent these noises from affecting Audio Cruise.

- 1 Start the engine and let it warm up.
- 2 Press and hold SEL (select) for more than 2 seconds so that one of the PSM items appears on the display.
- 3 Press ▲▶▶I or I◀◀▼ repeatedly until "CRUISE MODE" appears on the display.
- 4 Turn the control dial to select either "CRUISE 1" or "CRUISE 2."
- 5 Press ▲▶▶I (or I◀◀▼) to select "RPM SET."
- 6 Turn the control dial to select the desired idling speed.
- 7 Press SEL (select) to finish the setting.

**When the setting is complete**, the unit automatically checks to see if Audio Cruise functions correctly with this new idling setting. If it does not function correctly, Audio Cruise is canceled automatically and the idling setting becomes invalid.

- If this happens, see the NOTICE above.

# Assigning names to the sources

You can assign names to station frequencies and CDs. After assigning a name, it will appear on the display when you select the source.

Sources	Maximum number of the characters
Station frequencies	Up to 10 characters (up to 30 station frequencies including both FM and AM)
CDs * and CD changer *	Up to 32 characters (up to 40 discs)

\* You cannot assign a name to a CD Text.

**1** Select a source you want to assign a name to.



**2** Press and hold SEL (select) for more than 2 seconds while pressing DISP.

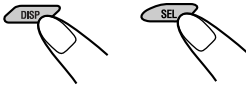

When you select a station frequency as the source:



When you select the CD as the source:

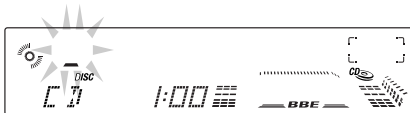

**3** Select a character.  
About the available characters, see below.

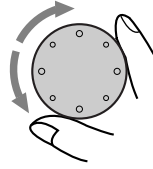

**4** Move the cursor to the next (or previous) character position.

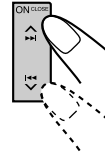

**5** Repeat steps 3 and 4 until you finish inputting the name.

**6** Press the button while the last selected character is flashing.  
The input name is stored in memory.

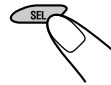

## To erase the input characters

Insert spaces using the same procedure described above.

## Available characters

A	B	C	D	E	F	G	H	I	J
K	L	M	N	O	P	Q	R	S	T
U	V	W	X	Y	Z	0	1	2	3
4	5	6	7	8	9	-	/	<	>
space									

## Notes:

- When you try to assign a name to the 41st disc, "NAME FULL" appears on the display. (In this case, delete unwanted names before assignment.)
- When the CD changer is connected, you can assign names to CDs in the CD changer. These names can also be shown on the display if you insert the CDs in this unit.

# CD CHANGER OPERATIONS

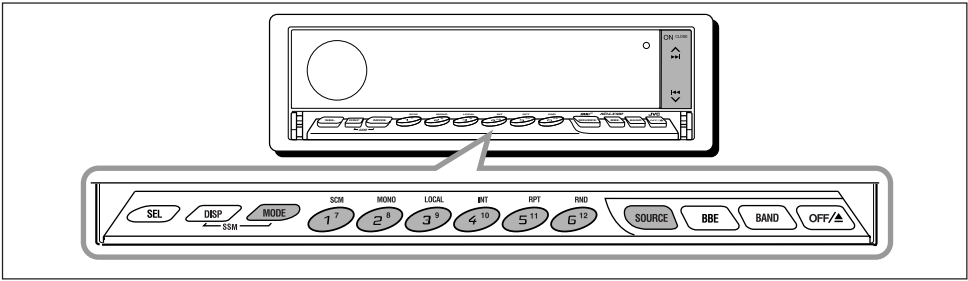

We recommend that you use one of the CH-X series with your unit.

If you have another CD automatic changer, consult your JVC IN-CAR ENTERTAINMENT dealer for connections.

- For example, if your CD automatic changer is one of the KD-MK series, you need a cord (KS-U15K) for connecting it to this unit.

Before operating your CD automatic changer:

- Refer also to the Instructions supplied with your CD changer.
- If no discs are in the magazine of the CD changer or the discs are inserted upside down, "NO DISC" will appear on the display. If this happens, remove the magazine and set the discs correctly.
- If "RESET 1" - "RESET 8" appears on the display, something is wrong with the connection between this unit and the CD changer. If this happens, check the connection, connect the connecting cord(s) firmly if necessary, then press the reset button of the CD changer.

## Playing CDs

### Select the CD automatic changer.

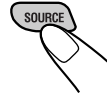

Each time you press the button, the source changes as described on page 7.

Playback starts from the first track of the first disc.

All tracks of all discs are played back.



Disc number appears.

### To fast-forward or reverse the track

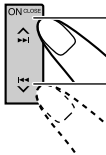

Press and hold ▲▶▶, while playing a CD, to fast-forward the track.

Press and hold ◀◀▼, while playing a CD, to reverse the track.

### To go to the next track or the previous tracks

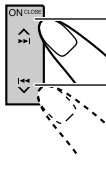

Press ▲▶▶ briefly, while playing a CD, to go ahead to the beginning of the next track. Each time you press the button consecutively, the beginning of the next track is located and played back.

Press ◀◀▼ briefly, while playing a CD, to go back to the beginning of the current track. Each time you press the button consecutively, the beginning of the previous tracks is located and played back.



### To go to a particular disc directly

Press the number button corresponding to the disc number to start its playback (while the CD changer is playing).

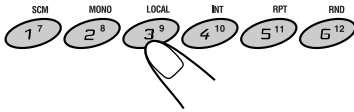

- To select a disc number from 1 – 6: Press 1 (7) – 6 (12) briefly.
- To select a disc number from 7 – 12: Press and hold 1 (7) – 6 (12) for more than 1 second.



Disc number

Ex. When disc number 3 is selected

### To show the CD Text information

This is possible only when connecting a JVC CD automatic changer equipped with CD Text reading capability.

See “Playing a CD Text” on page 13.

## Selecting CD playback modes

- There is a time limit in doing the following procedure. If the setting is cancelled before you finish, start from step 1 again.

### To play back tracks at random (Random Play)

- 1 Press MODE while playing a CD. “MODE” appears on the display.

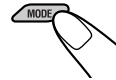

- 2 Press RND (random), while “MODE” is still on the display, so that the RND indicator lights up on the display. Each time you press the button, CD random play mode changes as follows:

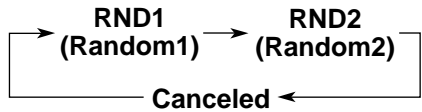
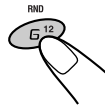

Mode	RND Indicator	Plays at random
RND1	Lights	All tracks of the current disc, then the tracks of the next disc, and so on.
RND2	Flashes	All tracks of all discs inserted in the magazine.



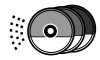

### To play back tracks repeatedly (Repeat Play)

1 Press MODE while playing a CD.  
"MODE" appears on the display.

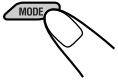

**Within  
5 seconds**

2 Press RPT (repeat), while "MODE" is still on the display, so that the RPT indicator lights up on the display.  
Each time you press the button, CD repeat play mode changes as follows:

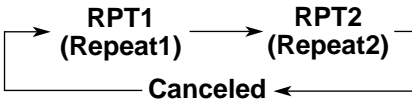
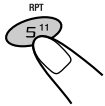

Mode	RPT Indicator	Plays repeatedly
RPT1	Lights	The current track (or specified track).
RPT2	Flashes	All tracks of the current disc (or specified disc).

### To play back only intros (Intro Scan)

1 Press MODE while playing a CD.  
"MODE" appears on the display.

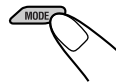

**Within  
5 seconds**

2 Press INT (intro), while "MODE" is still on the display.  
Each time you press the button, CD intro scan mode changes as follows:

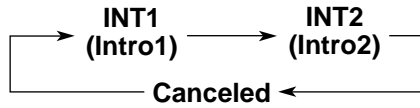
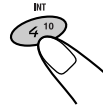

Mode	Indication	Plays the beginnings (15 seconds)
INT1	Track number flashes	Of all tracks on all inserted discs.
INT2	Disc number flashes (when it is shown on the display)	Of the first track on each inserted disc.



# EXTERNAL COMPONENT OPERATIONS

ENGLISH

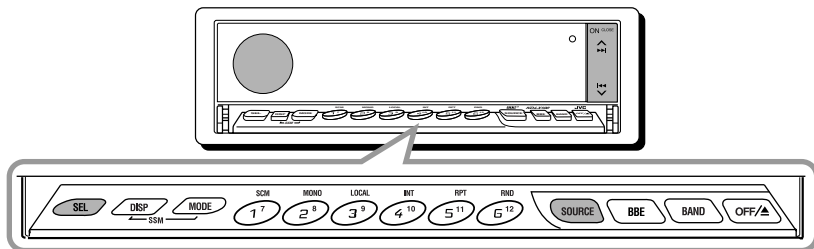

## Playing an external component

You can connect the external component to the CD changer jack on the rear using the Line Input Adaptor KS-U57 (not supplied).

### Preparations:

- For connecting the Line Input Adaptor KS-U57 and the external component, refer to the Installation/Connection Manual (separate volume).
- Before operating the external component using the following procedure, select the external input correctly. (See “To select the external component to use — EXT INPUT” on page 20.)

### 1 Select the external component.



Each time you press the button, the source changes as described on page 7.

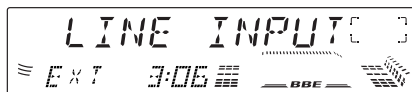

### 2 Operate the external component.

#### Note:

For the external component connection, see the Installation/Connection Manual (separate volume).

### 3 Adjust the volume.

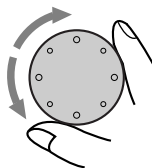

# TROUBLESHOOTING



What appears to be trouble is not always serious. Check the following points before calling a service centre.

Symptoms	Causes	Remedies
<ul style="list-style-type: none"> <li>CD cannot be played back.</li> </ul>	CD is inserted upside down.	Insert the CD correctly.
<ul style="list-style-type: none"> <li>CD sound is sometimes interrupted.</li> </ul>	You are driving on rough roads.	Stop CD play while driving on rough roads.
	CD is scratched.	Change the CD.
	Connections are incorrect.	Check the cords and connections.
<ul style="list-style-type: none"> <li>Sound cannot be heard from the speakers.</li> </ul>	The volume level is set to the minimum level.	Adjust it to the optimum level.
	Connections are incorrect.	Check the cords and connections.
<ul style="list-style-type: none"> <li>SSM (Strong-station Sequential Memory) automatic preset does not work.</li> </ul>	Signals are too weak.	Store stations manually.
<ul style="list-style-type: none"> <li>Static noise while listening to the radio.</li> </ul>	The antenna is not connected firmly.	Connect the antenna firmly.
<ul style="list-style-type: none"> <li>“NO DISC” appears on the display.</li> </ul>	No CD is in the magazine.	Insert CD.
<ul style="list-style-type: none"> <li>“RESET 8” appears on the display.</li> </ul>	This unit is not connected to a CD changer correctly.	Connect this unit and the CD changer correctly and press the reset button of the CD changer.
<ul style="list-style-type: none"> <li>“RESET 1” - “RESET 7” appears on the display.</li> </ul>	_____	Press the reset button of the CD changer.
<ul style="list-style-type: none"> <li>“EJECT ERR” appears on the display and CD cannot be ejected.</li> </ul>	The CD player may function incorrectly.	Press and hold <b>⏮</b> <b>⏭</b> for more than 5 seconds.
<ul style="list-style-type: none"> <li>No message appears on the display but CD cannot be ejected.</li> </ul>		While holding <b>⏮</b> <b>⏭</b> , press the reset button. Release the reset button, then release <b>⏮</b> <b>⏭</b> . (Be careful not to drop the CD when ejecting.)
<ul style="list-style-type: none"> <li>This unit does not work at all.</li> <li>The CD changer does not work at all.</li> </ul>	The built-in microcomputer may function incorrectly due to noise, etc.	Press the reset button on the front panel. (See page 2.)



# MAINTENANCE

ENGLISH

## Handling CDs

This unit has been designed to reproduce the CDs bearing the following marks.



You can play back your original CD-Rs (Recordable) and CD-RWs (Rewritable) on this receiver.

**This unit is not compatible with MP3.**

### How to handle CDs

**When removing a CD from its case**, press down the center holder of the case and lift the CD out, holding it by the edges.

- Always hold the CD by the edges. Do not touch its recording surface.

**When storing a CD into its case**, gently insert the CD around the center holder (with the printed surface facing up).

- Make sure to store CDs into the cases after use.

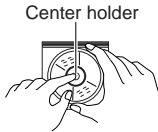

### To keep CDs clean

A dirty CD may not play correctly. If a CD does become dirty, wipe it with a soft cloth in a straight line from center to edge.



### To play new CDs

New CDs may have some rough spots around the inner and outer edges. If such a CD is used, this unit may reject the CD.

To remove these rough spots, rub the edges with a pencil or ball-point pen, etc.



## Moisture condensation

Moisture may condense on the lens inside the CD player in the following cases:

- After starting the heater in the car.
- If it becomes very humid inside the car.

Should this occur, the CD player may malfunction. In this case, eject the CD and leave the unit turned on for a few hours until the moisture evaporates.

## When playing a CD-R or CD-RW

User-edited CD-Rs (Recordable) and CD-RWs (Rewritable) can be played back only if they are already "finalized."

- You can play back your original CD-Rs or CD-RWs recorded in music CD format. (However, they may not be played back depending on their characteristics or recording conditions.)
- Before playing back CD-Rs or CD-RWs, read their instructions or cautions carefully.
- Some CD-Rs or CD-RWs may not be played back on this unit because of their disc characteristics, damage or stain on them, or if the player's lens is dirty.
- CD-Rs or CD-RWs are susceptible to high temperatures or high humidity; so do not leave them inside your car.
- CD-RWs may require a longer readout time. (This is caused by the fact that the reflectance of CD-RWs is lower than for regular CDs.)

### CAUTIONS:

- Do not insert 8cm (3 3/16") CDs (single CDs) into the loading slot. (Such CDs cannot be ejected.)
- Do not insert any CD of unusual shape – like a heart or flower; otherwise, it will cause a malfunction.
- Do not expose CDs to direct sunlight or any heat source or place them in a place subject to high temperature and humidity. Do not leave them in a car.
- Do not use any solvent (for example, conventional record cleaner, spray, thinner, benzine, etc.) to clean CDs.

### About mistracking:

Mistracking may result from driving on extremely rough roads. This does not damage the unit and the CD, but will be annoying.

We recommend that you stop CD play while driving on such rough roads.

## AUDIO AMPLIFIER SECTION

Maximum Power Output:

Front: 45 W per channel

Rear: 45 W per channel

Continuous Power Output (RMS):

Front: 17 W per channel into 4  $\Omega$ , 40 Hz to 20 000 Hz at no more than 0.8% total harmonic distortion.

Rear: 17 W per channel into 4  $\Omega$ , 40 Hz to 20 000 Hz at no more than 0.8% total harmonic distortion.

Load Impedance: 4  $\Omega$  (4  $\Omega$  to 8  $\Omega$  allowance)

Tone Control Range:

Bass:  $\pm 10$  dB at 100 Hz

Treble:  $\pm 10$  dB at 10 kHz

Frequency Response: 40 Hz to 20 000 Hz

Signal-to-Noise Ratio: 70 dB

Line-Out Level/Impedance:

2.0 V/20 k $\Omega$  load (full scale)

Output Impedance: 1 k $\Omega$

## TUNER SECTION

Frequency Range:

FM: 87.5 MHz to 107.9 MHz  
(with channel interval set to 200 kHz)

87.5 MHz to 108.0 MHz  
(with channel interval set to 50 kHz)

AM: 530 kHz to 1 710 kHz  
(with channel interval set to 10 kHz)  
531 kHz to 1 602 kHz  
(with channel interval set to 9 kHz)

### **[FM Tuner]**

Usable Sensitivity: 11.3 dBf (1.0  $\mu$ V/75  $\Omega$ )

50 dB Quietening Sensitivity:

16.3 dBf (1.8  $\mu$ V/75  $\Omega$ )

Alternate Channel Selectivity (400 kHz):

65 dB

Frequency Response: 40 Hz to 15 000 Hz

Stereo Separation: 35 dB

Capture Ratio: 1.5 dB

### **[AM Tuner]**

Sensitivity: 20  $\mu$ V

Selectivity: 35 dB

## CD PLAYER SECTION

Type: Compact disc player

Signal Detection System: Non-contact optical pickup (semiconductor laser)

Number of channels: 2 channels (stereo)

Frequency Response: 5 Hz to 20 000 Hz

Dynamic Range: 96 dB

Signal-to-Noise Ratio: 98 dB

Wow and Flutter: Less than measurable limit

## GENERAL

Power Requirement:

Operating Voltage: DC 14.4 V  
(11 V to 16 V allowance)

Grounding System: Negative ground

Allowable Operating Temperature:  
0°C to +40°C (32°F to 104°F)

Dimensions (W  $\times$  H  $\times$  D):

Installation Size:  
182 mm  $\times$  52 mm  $\times$  160 mm  
(7-3/16"  $\times$  2-1/16"  $\times$  6-5/16")

Panel Size:

188 mm  $\times$  58 mm  $\times$  8 mm  
(7-7/16"  $\times$  2-5/16"  $\times$  3/8")

Mass: 1.7 kg (3.8 lbs)  
(excluding accessories)

*Design and specifications subject to change without notice.*

If a kit is necessary for your car, consult your telephone directory for the nearest car audio speciality shop.



**JVC**  
**MOBILE**  
ENTERTAINMENT

<http://www.jvcmobile.com>

*Visit us on-line for  
Technical Support & Customer Satisfaction Survey.*

**US RESIDENTS ONLY**

**Having TROUBLE with operation?  
Please reset your unit**

Refer to page of How to Reset  
**Still having trouble??**

**USA ONLY**

**Call 1-800-252-5722**

<http://www.jvcservice.com>

**We can help you!**

**JVC**

VICTOR COMPANY OF JAPAN, LIMITED



## CAUTION / ACHTUNG / ATTENTION / LET OP

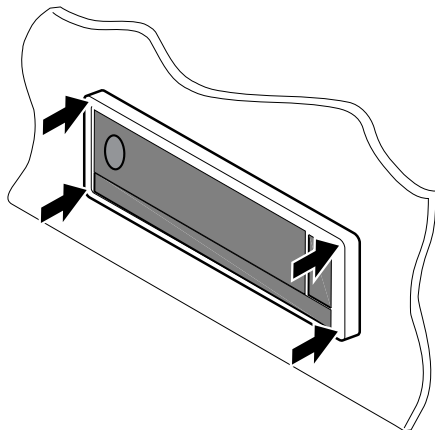

### ENGLISH

To install this unit, attach the trim plate to the unit first, then fit the unit into the mounting sleeve by pressing the four corners of the trim plate.

**DO NOT** press the panel (shaded in the illustration); otherwise the panel may become unable to open or close.

### DEUTSCH

Um dieses Gerät zu installieren, bringen Sie zunächst den Zierrahmen am Gerät an. Schieben Sie anschließend das Gerät in die Schutzhülle, indem Sie auf die vier Ecken des Zierrahmens drücken.

Drücken Sie **NICHT** auf die Blende (die in der Abbildung dunkelgetönt dargestellt ist); anderenfalls läßt sich die Blende weder öffnen noch schließen.

### FRANÇAIS

Pour installer cet appareil, fixez d'abord la plaque d'assemblage à l'appareil, puis ajustez l'appareil dans le manchon en appuyant sur les quatre coins de la plaque d'assemblage. **N'APPUYEZ PAS** sur le panneau (partie ombrée sur l'illustration); sinon le panneau risque de ne pas pouvoir s'ouvrir ou se fermer.

### NEDERLANDS

Om dit apparaat te installeren, dient u eerst de sierplaat op het apparaat te bevestigen, daarna het apparaat in de behuizing te plaatsen en de vier hoeken van de sierplaat aan te drukken.

Druk **NIET** op het paneel (gearceerd in de illustratie aangegeven), anders loopt u het risico dat het paneel niet meer kan worden geopend of gesloten.

Notice the following information will help you solve the problems.  
Keep this IMPORTANT sheet together with the INSTRUCTIONS book.

- **After installing the unit**
  - Follow the procedure [A] described below.
- **If the unit does not operate**
  - Follow the procedure [A] described below.
- **If a CD is not ejected from the loading slot**
  - ① “EJECT ERR” or “EJECT ERROR” appears on the display
    - Follow the procedure [B] described below. (If the procedure [B] does not work, try the procedure [A].)
  - ② No message appears on the display
    - Follow the procedure [C] described below.
- **If a CD is not recognized (the source does not change to the CD) even though there is a CD in the loading slot**
  - Follow the procedure [C] described below. (If the procedure [C] does not work, try the procedure [A].)

## [A] To reset the microcomputer

Press the reset button on the front panel using a ball-point pen or a similar tool.  
This will reset the built-in microcomputer.

**NOTE:** Your preset adjustments — such as preset channels or sound adjustments — will also be erased.

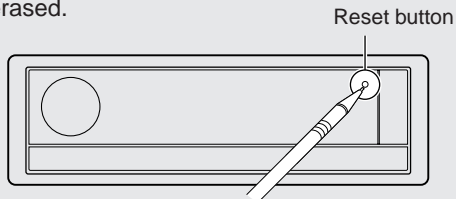

## [B] To eject a CD by force

Press and hold ◀◀ ▼ button until CD ejects.

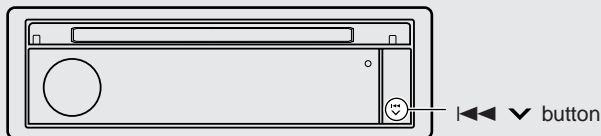

## [C] To eject a CD by force

While holding ▲▶▶, press the reset button. Release the reset button, then release ▲▶▶. (Be careful not to drop the CD when ejecting.)

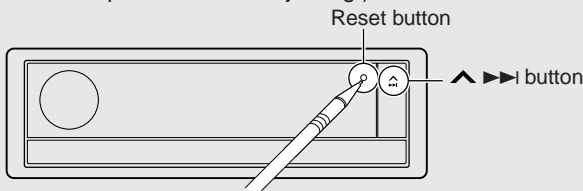



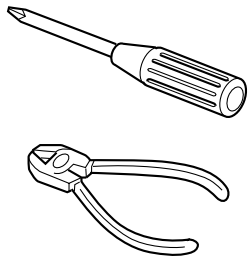

#### ENGLISH

- This unit is designed to operate on 12 V DC, NEGATIVE ground electrical systems.

## INSTALLATION (IN-DASH MOUNTING)

- The following illustration shows a typical installation. However, you should make adjustments corresponding to your specific car. If you have any questions or require information regarding installation kits, consult your JVC car audio dealer or a company supplying kits.

- Remove the trim plate.
- Remove the sleeve after disengaging the sleeve locks.
  - Stand the unit.
 

**Note:** When you stand the unit, be careful not to damage the fuse on the rear.
  - Insert the 2 handles between the unit and the sleeve, as illustrated, to disengage the sleeve locks.
  - Remove the sleeve.
 

**Note:** Be sure to keep the handles for future use after installing the unit.
- Attach the trim plate.
- Install the sleeve into the dashboard.
 

\* After the sleeve is correctly installed into the dashboard, bend the appropriate tabs to hold the sleeve firmly in place, as illustrated.
- Fix the mounting bolt to the rear of the unit's body and place the rubber cushion over the end of the bolt.
- Do the required electrical connections.
- Slide the unit into the sleeve until it is locked by pressing the four corners of the trim plate.
 

**Note:** Do not press the panel (shaded in the illustration); otherwise the panel may become unable to open or close.

#### ESPAÑOL

- Esta unidad está diseñada para funcionar con 12 V de CC, con sistemas eléctricos de masa NEGATIVA.

## INSTALACION (MONTAJE EN EL TABLERO DE INSTRUMENTOS)

- La siguiente ilustración muestra una instalación típica. Sin embargo usted deberá efectuar los ajustes correspondientes a su automóvil. Si tiene alguna pregunta o necesita información acerca de las herramientas para instalación, consulte con su concesionario de JVC de equipos de audio para automóviles o a una compañía que suministra tales herramientas.

- Retire la placa de guarnición.
- Retire la cubierta después de desenganchar los retenes de la cubierta.
  - Ponga la unidad vertical.
 

**Nota:** Al poner la unidad vertical, tenga cuidado de no dañar el fusible provisto en la parte posterior.
  - Inserte las dos manijas entre la unidad y la cubierta tal como en la ilustración y desenganche los retenes de la cubierta.
  - Retire la cubierta.
 

**Nota:** Después de instalar la unidad, asegúrese de guardar las manijas para uso futuro.
- Instale la placa de guarnición.
- Instale la cubierta en el tablero de instrumentos.
 

\* Después de que la cubierta esté correctamente instalada en el tablero de instrumentos, doble las lengüetas correspondientes para sostener la cubierta firmemente en su lugar, tal como se muestra.
- Fije el perno de montaje en la parte trasera del cuerpo de la unidad y coloque el cojín de goma sobre el extremo del perno.
- Realice las conexiones eléctricas requeridas.
- Deslice la unidad dentro de la cubierta hasta que quede bloqueada al presionar contra las cuatro esquinas de la placa de guarnición.
 

**Nota:** No presione el panel (sombreado en la ilustración); de lo contrario, podría suceder que no se pueda realizar su apertura o cierre.

#### FRANÇAIS

- Cet appareil est conçu pour fonctionner sur des sources de courant continu de 12 V à masse NEGATIVE.

## INSTALLATION (MONTAGE DANS LE TABLEAU DE BORD)

- L'illustration suivante est un exemple d'installation typique. Cependant, vous devez faire les ajustements correspondant à votre voiture particulière. Si vous avez des questions ou avez besoin d'information sur des kits d'installation, consulter votre revendeur d'autoradios JVC ou une compagnie d'approvisionnement.

- Retirer la plaque d'assemblage.
- Libérer les verrous du manchon et retirer le manchon.
  - Poser l'appareil à la verticale.
 

**Remarque:** Lorsque vous mettez l'appareil à la verticale, faire attention de ne pas endommager le fusible situé sur l'arrière.
  - Insérer les 2 poignées entre l'appareil et le manchon comme indiqué pour désengager les verrous de manchon.
  - Retirer le manchon.
 

**Remarque:** S'assurer de garder les poignées pour une utilisation ultérieure, après l'installation de l'appareil.
- Fixez la plaque d'assemblage.
- Installer le manchon dans le tableau de bord.
 

\* Après installation correcte du manchon dans le tableau de bord, plier les bonnes pattes pour maintenir fermement le manchon en place, comme montré.
- Monter le boulon de montage sur l'arrière du corps de l'appareil puis passer l'amortisseur en caoutchouc sur l'extrémité du boulon.
- Réalisez les connexions électriques.
- Faites glisser l'appareil dans le manchon jusqu'à ce qu'il soit verrouillé en appuyant sur les quatre coins de la plaque d'assemblage.
 

**Remarque:** N'appuyez pas sur le panneau (ombré sur l'illustration); sinon le panneau risquerait de ne pas pouvoir s'ouvrir ou se fermer.

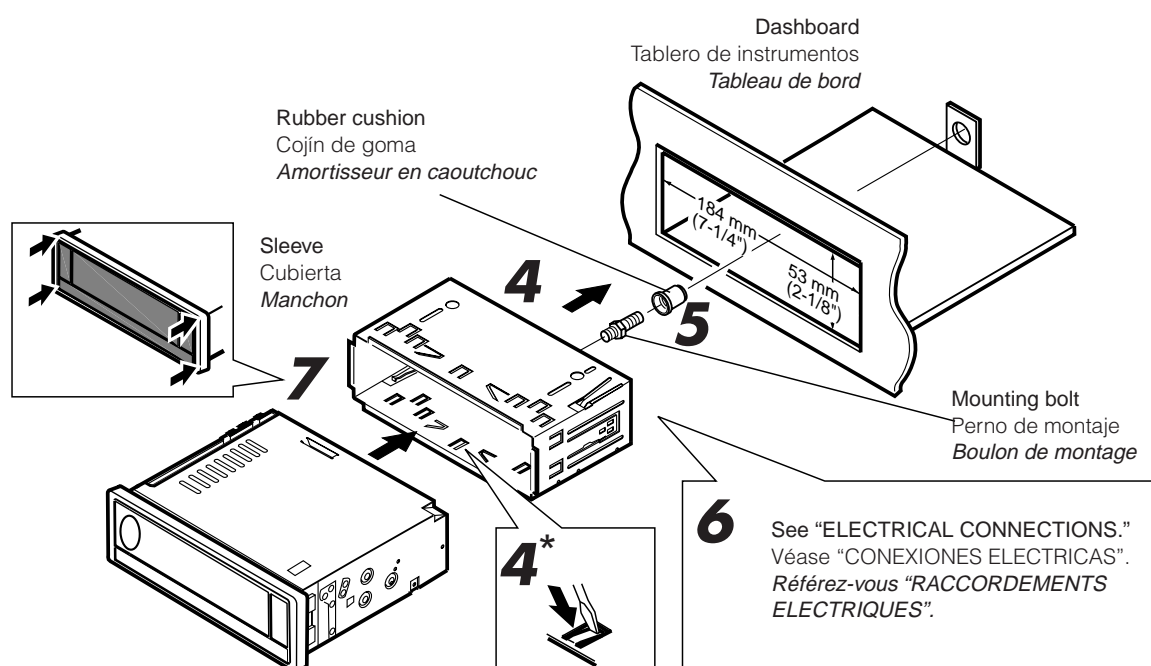
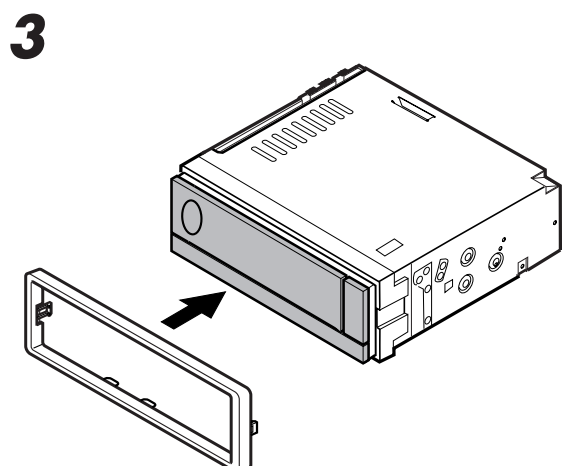
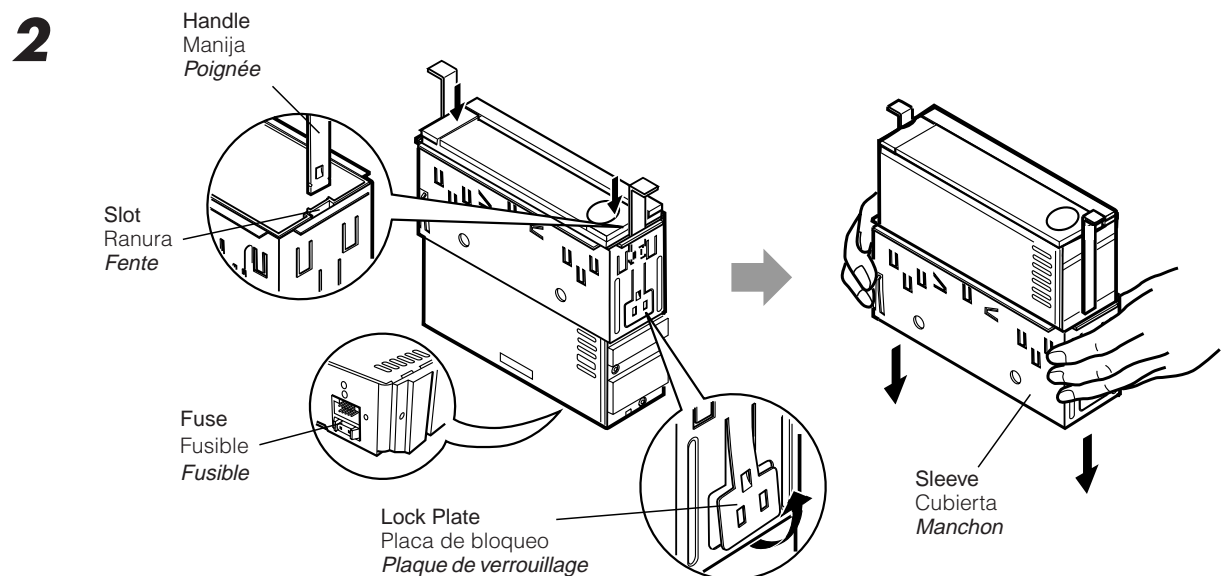
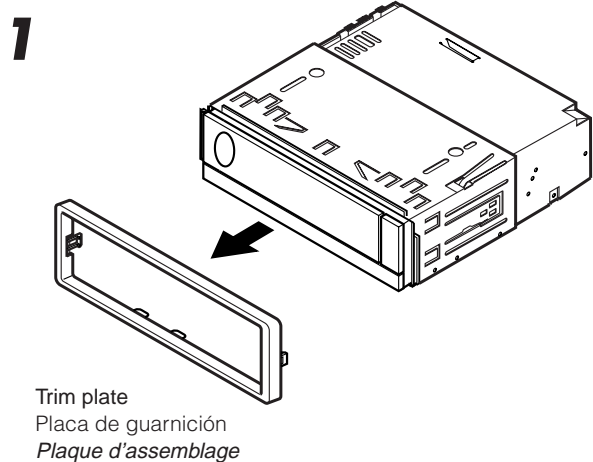

- See "ELECTRICAL CONNECTIONS."  
Véase "CONEXIONES ELECTRICAS".  
Référez-vous "RACCORDEMENTS ELECTRIQUES".

- When using the optional stay
- Cuando emplea un soporte opcional
- Lors de l'utilisation du hauban en option

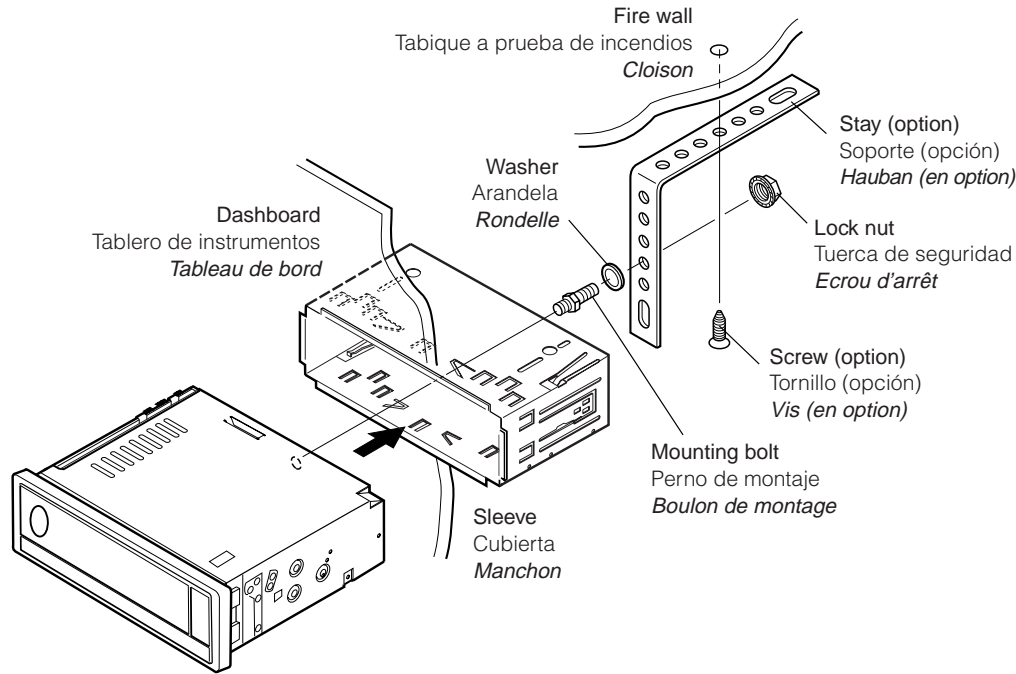

- When installing the unit without using the sleeve
- Instalación de la unidad sin utilizar la cubierta
- Lors de l'installation de l'appareil sans utiliser de manchon

In a Toyota for example, first remove the car radio and install the unit in its place.  
En un Toyota por ejemplo, primero extraiga la radio del automóvil y luego instale la unidad en su lugar.  
Par exemple dans une Toyota, retirer d'abord l'autoradio et installer l'appareil à la place.

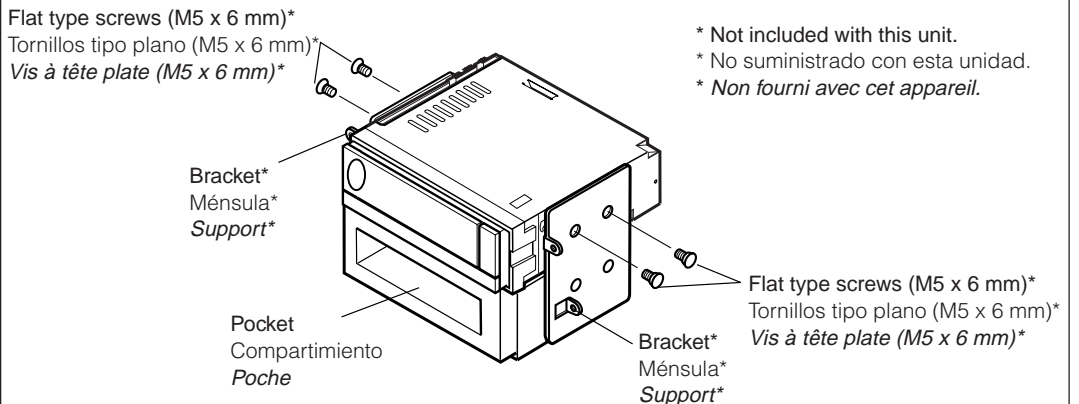

\* Not included with this unit.  
\* No suministrado con esta unidad.  
\* Non fourni avec cet appareil.

**Note:** When installing the unit on the mounting bracket, make sure to use the 6 mm-long screws. If longer screws are used, they could damage the unit.

**Nota:** Cuando instala la unidad en la ménsula de montaje, asegúrese de utilizar los tornillos de 6 mm de longitud. Si se utilizan tornillos más largos, éstos pueden dañar la unidad.

**Remarque:** Lors de l'installation de l'appareil sur le support de montage, s'assurer d'utiliser des vis d'une longueur de 6 mm. Si des vis plus longues sont utilisées, elles peuvent endommager l'appareil.

### Removing the unit

- Before removing the unit, release the rear section.

- 1 Remove the trim plate.
- 2 Insert the 2 handles into the slots, as shown. Then, while gently pulling the handles away from each other, slide out the unit. (Be sure to keep the handles after installing it.)

### Extracción de la unidad

- Antes de extraer la unidad, libere la sección trasera.

- 1 Retire la placa de guarnición.
- 2 Inserte las 2 manijas entre las ranuras, como se muestra. Luego, separe gentilmente las manijas y extraiga la unidad. (Asegúrese de conservar las manijas después de instalarlo.)

### Retrait de l'appareil

- Avant de retirer l'appareil, libérer la section arrière.

- 1 Retirer la plaque d'assemblage.
- 2 Introduire les deux poignées dans les fentes, comme montré. Puis, tout en tirant doucement les poignées écartées, faire glisser l'appareil pour le sortir. (S'assurer de conserver les poignées après l'installation de l'appareil.)

1

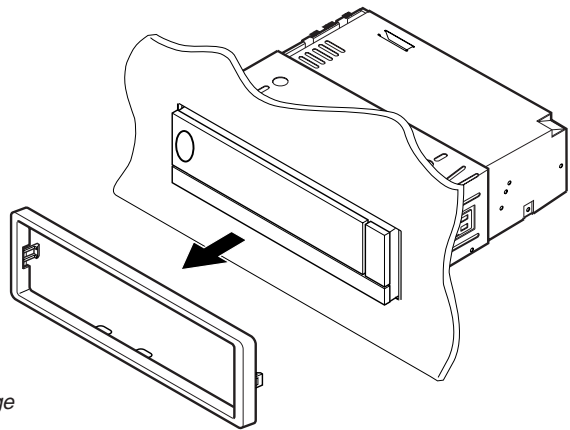

Trim plate  
Placa de guarnición  
Plaque d'assemblage

2

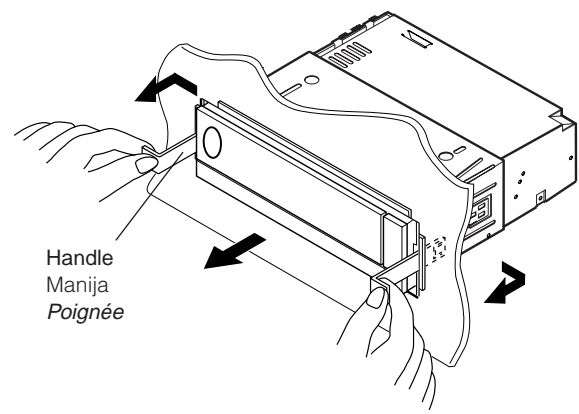

Handle  
Manija  
Poignée

### Parts list for installation and connection

The following parts are provided with this unit.  
After checking them, please set them correctly.

### Lista de piezas para instalación y conexión

Con esta unidad se suministran las siguientes piezas.  
Después de inspeccionarlas, colóquelas correctamente.

### Liste des pièces pour l'installation et raccordement

Les pièces suivantes sont fournies avec cet appareil.  
Après vérification, veuillez les placer correctement.

Sleeve  
Cubierta  
Manchon

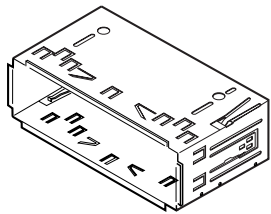

Trim plate  
Placa de guarnición  
Plaque d'assemblage

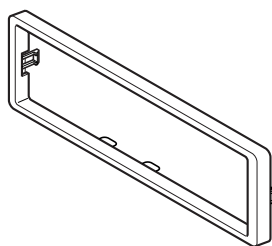

Remote controller  
Control remoto  
Télécommande

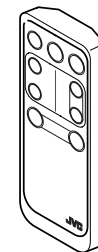

Battery  
Pila  
Pile



CR2025

Power cord  
Cordón de alimentación  
Cordon d'alimentation

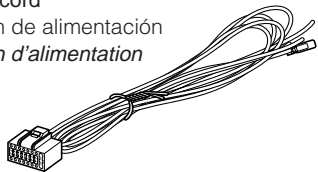

Handles  
Manijas  
Poignées

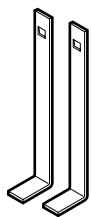

Washer (ø5)  
Arandela (ø5)  
Rondelle (ø5)



Lock nut (M5)  
Tuerca de seguridad (M5)  
Ecrou d'arrêt (M5)



Mounting bolt (M5 x 20 mm)  
Perno de montaje (M5 x 20 mm)  
Boulon de montage (M5 x 20 mm)



Rubber cushion  
Cojín de goma  
Amortisseur en caoutchouc



## ELECTRICAL CONNECTIONS

To prevent short circuits, we recommend that you disconnect the battery's negative terminal and make all electrical connections before installing the unit. If you are not sure how to install this unit correctly, have it installed by a qualified technician.

### Note:

This unit is designed to operate on **12 V DC, NEGATIVE ground electrical systems**. If your vehicle does not have this system, a voltage inverter is required, which can be purchased at JVC car audio dealers.

- Replace the fuse with one of the specified rating. If the fuse blows frequently, consult your JVC car audio dealer.
- If noise is a problem... This unit incorporates a noise filter in the power circuit. However, with some vehicles, clicking or other unwanted noise may occur. If this happens, connect the unit's **rear ground terminal** (See connection diagram.) to the car's chassis using shorter and thicker cords, such as copper braiding or gauge wire. If noise still persists, consult your JVC car audio dealer.
- Maximum input of the speakers:  
For KD-LX300: Maximum input of the speakers should be more than 50 W at the rear and 50 W at the front, with an impedance of **4 Ω to 8 Ω**.  
For KD-LX100: Maximum input of the speakers should be more than 45 W at the rear and 45 W at the front, with an impedance of **4 Ω to 8 Ω**.
- **Be sure to ground this unit to the car's chassis.**
- The heat sink becomes very hot after use. Be careful not to touch it when removing this unit.

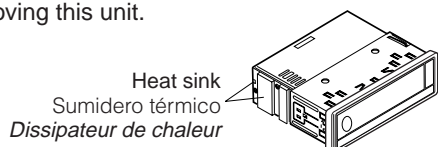

## CONEXIONES ELECTRICAS

Para evitar cortocircuitos, recomendamos que desconecte el terminal negativo de la batería y que efectúe todas las conexiones eléctricas antes de instalar la unidad. Si usted no está seguro de cómo instalar correctamente la unidad, hágala instalar por un técnico cualificado.

### Nota:

Esta unidad está diseñada para funcionar con **12 V de CC, con sistemas eléctricos de masa NEGATIVA**. Si su vehículo no posee este sistema, será necesario un inversor de tensión, que puede ser adquirido en los concesionarios de JVC de equipos de audio para automóviles.

- Reemplace el fusible por uno con la corriente especificada. Si el fusible se quemase frecuentemente consulte con su concesionario de JVC de equipos de audio para automóviles.
- Si el ruido fuese un problema... Esta unidad tiene un filtro de ruido en el circuito de alimentación. Sin embargo, en algunos vehículos, pueden producirse chasquidos u otros ruidos indeseados. En tal caso conecte el **terminal de tierra posterior** (Véase diagrama de conexión.) del receptor al chasis del automóvil, utilizando cordones más gruesos y cortos tales como alambre de cobre trenzado o de grueso calibre. Si el ruido persiste, consulte a su concesionario de JVC de equipos de audio para automóvil.
- La entrada máxima de los altavoces:  
Para KD-LX300: La entrada máxima de los altavoces traseros debe ser mayor de 50 W y la de los delanteros de 50 W, con una impedancia de **4 Ω a 8 Ω**.  
Para KD-LX100: La entrada máxima de los altavoces traseros debe ser mayor de 45 W y la de los delanteros de 45 W, con una impedancia de **4 Ω a 8 Ω**.
- **Asegúrese de conectar esta unidad a tierra en el chasis del automóvil.**
- El sumidero térmico estará muy caliente después del uso. Asegúrese de no tocarlo al desmontar esta unidad.

## RACCORDEMENTS ELECTRIQUES

Pour éviter tout court-circuit, nous vous recommandons de débrancher la borne négative de la batterie et d'effectuer tous les raccordements électriques avant d'installer l'appareil. Si l'on n'est pas sûr de pouvoir installer correctement cet appareil, le faire installer par un technicien qualifié.

### Remarque:

Cet appareil est conçu pour fonctionner sur des sources de courant continu de **12 V à masse NEGATIVE**. Si votre véhicule n'offre pas ce type d'alimentation, il vous faut un convertisseur de tension, que vous pouvez acheter chez un revendeur d'autoradios JVC.

- Remplacer le fusible par un de la valeur précisée. Si le fusible saute souvent, consulter votre revendeur d'autoradios JVC.
- Si le bruit est un problème... Cet appareil incorpore un filtre de bruit dans le circuit d'alimentation. Cependant, avec certains véhicules, quelques claquements ou autres bruits non désirés risquent de se produire. Si cela arrive, raccorder la **borne arrière de masse de l'appareil au châssis de la voiture** (voir le schéma de raccordement) en utilisant des cordons les plus gros et les plus courts possibles telle qu'une barre de cuivre ou une tresse. Si le bruit persiste, consulter votre revendeur d'autoradios JVC.
- La puissance admissible des enceintes:  
Pour le KD-LX300: La puissance admissible des enceintes doit être supérieure à 50 W à l'arrière et à 50 W l'avant, avec une impedância de **4 Ω à 8 Ω**.  
Pour le KD-LX100: La puissance admissible des enceintes doit être supérieure à 45 W à l'arrière et à 45 W l'avant, avec une impedância de **4 Ω à 8 Ω**.
- **S'assurer de raccorder la mise à la masse de cet appareil au châssis de la voiture.**
- Le dissipateur de chaleur devient très chaud après usage. Faire attention de ne pas le toucher en retirant cet appareil.



**PRECAUTIONS on power supply and speaker connections:**

- **DO NOT** connect the speaker leads of the power cord to the car battery; otherwise, the unit will be seriously damaged.
- Connect the black lead (ground), yellow lead (to car battery, constant 12 V), and red lead (to an accessory terminal) correctly.
- **BEFORE** connecting the speaker leads of the power cord to the speakers, check the speaker wiring in your car.
  - If the speaker wiring in your car is as illustrated in Fig. 1 and Fig. 2 below, **DO NOT** connect the unit using that original speaker wiring. If you do, the unit will be seriously damaged. Redo the speaker wiring so that you can connect the unit to the speakers as illustrated in Fig. 3.
  - If the speaker wiring in your car is as illustrated in Fig. 3, you can connect the unit using the original speaker wiring in your car.
  - If you are not sure of the speaker wiring of your car, consult your car dealer.

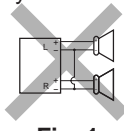

Fig. 1

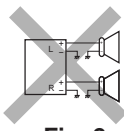

Fig. 2



Fig. 3

**PRECAUCIONES sobre las conexiones de la fuente de alimentación y de los altavoces:**

- **NO** conecte los conductores de altavoz del cable de alimentación a la batería de automóvil, pues podrían producirse graves daños en la unidad.
- Conecte correctamente el conductor negro (a tierra), el conductor amarillo (a la batería del automóvil, 12 V constantes), y el conductor rojo (a un terminal de accesorio).
- **ANTES** de conectar a los altavoces los conductores de altavoz del cable de alimentación, verifique el conexionado de altavoz de su automóvil.
  - Si el conexionado de altavoz de su automóvil es como se indica en las Fig. 1 y Fig. 2 de abajo, **NO** conecte la unidad utilizando ese conexionado de altavoz original. Si lo hace, se producirán daños graves en la unidad. Vuelva a efectuar el conexionado de altavoz de manera que pueda conectar la unidad a los altavoces de la manera indicada en la Fig. 3.
  - Si el conexionado de altavoz de su automóvil es como se indica en la Fig. 3, podrá conectar la unidad utilizando el conexionado de altavoz original de su automóvil.
  - Si tiene dudas sobre el conexionado de altavoz de su automóvil, consulte con su concesionario.

**PRECAUTIONS sur l'alimentation et la connexion des enceintes:**

- **NE CONNECTEZ PAS** les fils d'enceintes du cordon d'alimentation à la batterie; sinon, l'appareil serait sérieusement endommagé.
- Connectez correctement le fil noir (à la masse), le fil jaune (à la batterie de la voiture, 12 V constant) et le fil rouge (à la prise accessoire).
- **AVANT** de connecter les fils des enceintes du cordon d'alimentation aux enceintes, vérifiez le câblage des enceintes de votre voiture.
  - Si le câblage des enceintes de votre voiture est réalisé comme montré sur la Fig. 1 ou Fig. 2 ci-dessous, **NE CONNECTEZ PAS** l'appareil en utilisant ce câblage original d'enceintes. Si vous le faites, l'appareil sera sérieusement endommagé. Recommencez le câblage des enceintes de façon que vous puissiez connecter l'appareil aux enceintes comme montré sur la Fig. 3.
  - Si le câblage des enceintes de votre voiture est comme montré sur la Fig. 3, vous pouvez connecter l'appareil en utilisant ce câblage original d'enceintes pour votre voiture.
  - Si vous n'êtes pas sûrs du câblage d'enceintes de votre voiture, consultez le concessionnaire de votre voiture.

**Connecting the leads / Conexión de los conductores / Raccordement des fils**

Twist the core wires when connecting. Retuerce los alambres de alma para conectarlos. Torsader les âmes des fils en les raccordant.

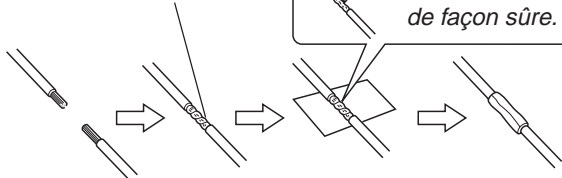

Solder the core wires to connect them securely. Suelde los alambres de alma para conectarlos con firmeza. Souder les âmes des fils pour les raccorder entre eux de façon sûre.

**CAUTION / PRECAUCION / PRECAUTION:**

- To prevent short-circuit, cover the terminals of the UNUSED leads with insulating tape.
- Para evitar cortocircuitos, cubra los cables NO UTILIZADOS con cinta aislante.
- Pour éviter les court-circuits, couvrir les bornes des fils qui ne sont PAS utilisés avec de la bande isolante.

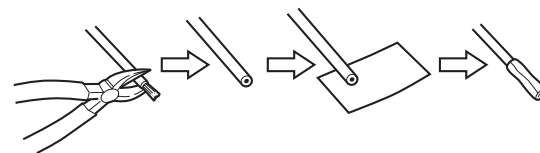

**A Typical Connections / Conexiones típicas / Raccordements typiques**

**Before connecting:** Check the wiring in the vehicle carefully. Incorrect connection may cause serious damage to this unit.

- 1 Connect the colored leads of the power cord to the car battery, speakers and power antenna (if any) in the following sequence.
  - ① Black: ground
  - ② Yellow: to car battery (constant 12 V)
  - ③ Red: to an accessory terminal
  - ④ Blue with white stripe: to power antenna (200 mA max.)
  - ⑤ Orange with white stripe: to car light control switch
  - ⑥ Others: to speakers
- 2 Connect the antenna cord.
- 3 Finally connect the wiring harness to the unit.

**Antes de la conexión:** Verifique atentamente el conexionado del vehículo. Una conexión incorrecta podría producir daños graves en la unidad.

- 1 Conecte los conductores de color del cable de alimentación a la batería del automóvil, altavoces y antena motriz (si la hubiere) en la secuencia siguiente.
  - ① Negro: a tierra
  - ② Amarillo: a la batería del automóvil (12 V constantes)
  - ③ Rojo: a un terminal de accesorio
  - ④ Azul con rayas blancas: a la antena motriz (máx. 200 mA)
  - ⑤ Naranja con rayas blancas: al interruptor de control de las luces del automóvil
  - ⑥ Otros: a los altavoces
- 2 Conecte el cable de antena.
- 3 Por último, conecte el cable de alimentación a la unidad.

**Avant de commencer la connexion:** vérifiez attentivement le câblage du véhicule. Une connexion incorrecte peut endommager sérieusement l'appareil.

- 1 Connectez les fils de couleur du cordon d'alimentation à la batterie de la voiture, aux enceintes et à l'antenne automatique (s'il y en a une) dans l'ordre suivant.
  - ① Noir: à la masse
  - ② Jaune: à la batterie de la voiture (12 V constant)
  - ③ Rouge: à la prise accessoire
  - ④ Bleu avec bande blanche: à l'antenne automatique (200 mA max.)
  - ⑤ Orange avec bande blanche: à l'interrupteur d'éclairage de la voiture
  - ⑥ Autres: aux enceintes
- 2 Connectez le cordon d'antenne.
- 3 Finalement, connectez le faisceau de fils à l'appareil.

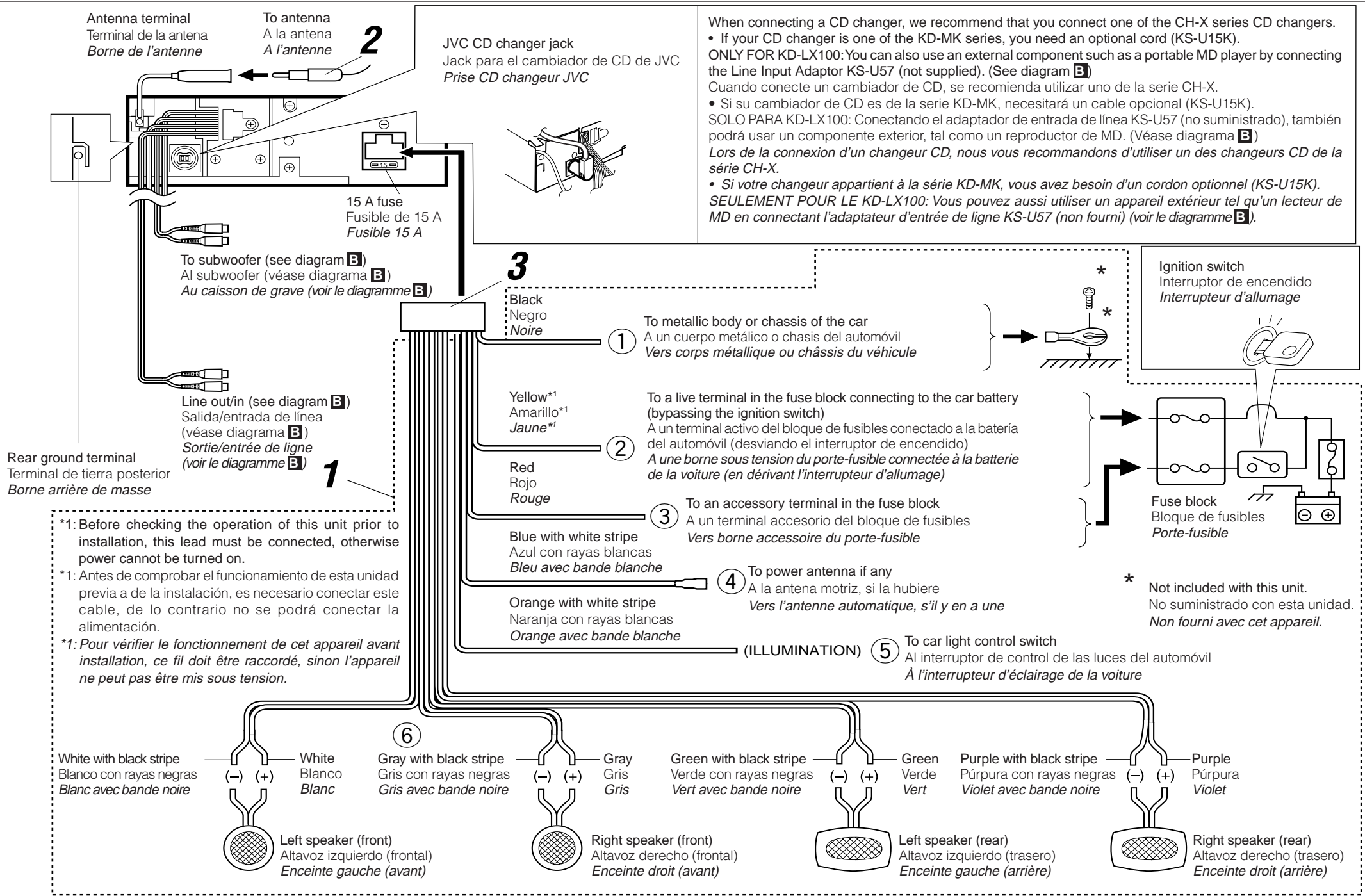

## B Connections Adding Other Equipment / Conexiones para añadir otros equipos / Raccordement pour ajouter d'autres appareils

You can connect an amplifier and other equipment to upgrade your car stereo system. For their connections, refer to the instructions supplied with each component.

- Connect the remote lead (blue with white stripe) to the remote lead of the other equipment so that it can be controlled through this unit.
- For amplifier only:
  - Disconnect the speakers from this unit, connect them to the amplifier. Leave the speaker leads of this unit unused.
  - ONLY FOR KD-LX300: The line output level of this unit is kept high to maintain the hi-fi sounds reproduced from this unit. **When connecting an external amplifier to this unit,** turn down the gain control on the external amplifier to obtain the best performance from this unit.
- ONLY FOR KD-LX300: Connect this unit's SUBWOOFER OUT plugs to the amplifier's line-in jacks.

Usted podrá conectar un amplificador y otros equipos para mejorar el sistema estéreo de su automóvil. Para las conexiones, refiérase a las instrucciones suministradas con cada componente.

- Conecte el conductor remoto (azul con rayas blancas) al conductor remoto del otro equipo para poderlo controlar a través de esta unidad.
- Sólo para el amplificador:
  - Desconecte los altavoces de esta unidad y conéctelos al amplificador. Los cables de los altavoces de esta unidad quedan sin usar.
  - SOLO PARA KD-LX300: El nivel de salida de línea de esta unidad permanece alto para que corresponda con los sonidos de alta fidelidad reproducidos por esta unidad. **Cuando conecte un amplificador externo a esta unidad,** disminuya el control de ganancia del amplificador externo para obtener un óptimo rendimiento de esta unidad.
- SOLO PARA KD-LX300: Conecte las clavijas SUBWOOFER OUT de esta unidad a los jacks de entrada de línea del amplificador.

Vous pouvez connecter un amplificateur ou autre appareil pour améliorer votre système autoradio. Pour leur connexion, référez-vous aux instructions fournies avec chaque appareil.

- Connectez le fil de commande à distance (bleu avec bande blanche) au fil de commande à distance de l'autre appareil de façon qu'il puisse être commandé via cet appareil.
- Pour l'amplificateur seulement:
  - Déconnectez les enceintes de cet appareil et connectez-les à l'amplificateur. Laissez les fils d'enceintes de cet appareil inutilisés.
  - SEULEMENT POUR LE KD-LX300: Le niveau de sortie de ligne de cet appareil est maintenu à un niveau élevé pour maintenir une qualité Hi-Fi pour les sons reproduits par cet appareil. **Lors de la connexion d'un amplificateur extérieur à cet appareil,** diminuez le réglage du gain sur l'amplificateur extérieur pour obtenir les meilleures performances de cet appareil.
- SEULEMENT POUR LE KD-LX300: Connectez les fiches SUBWOOFER OUT de cet appareil aux prises d'entrée de ligne de l'amplificateur.

### Amplifier / Amplificador / Amplificateur

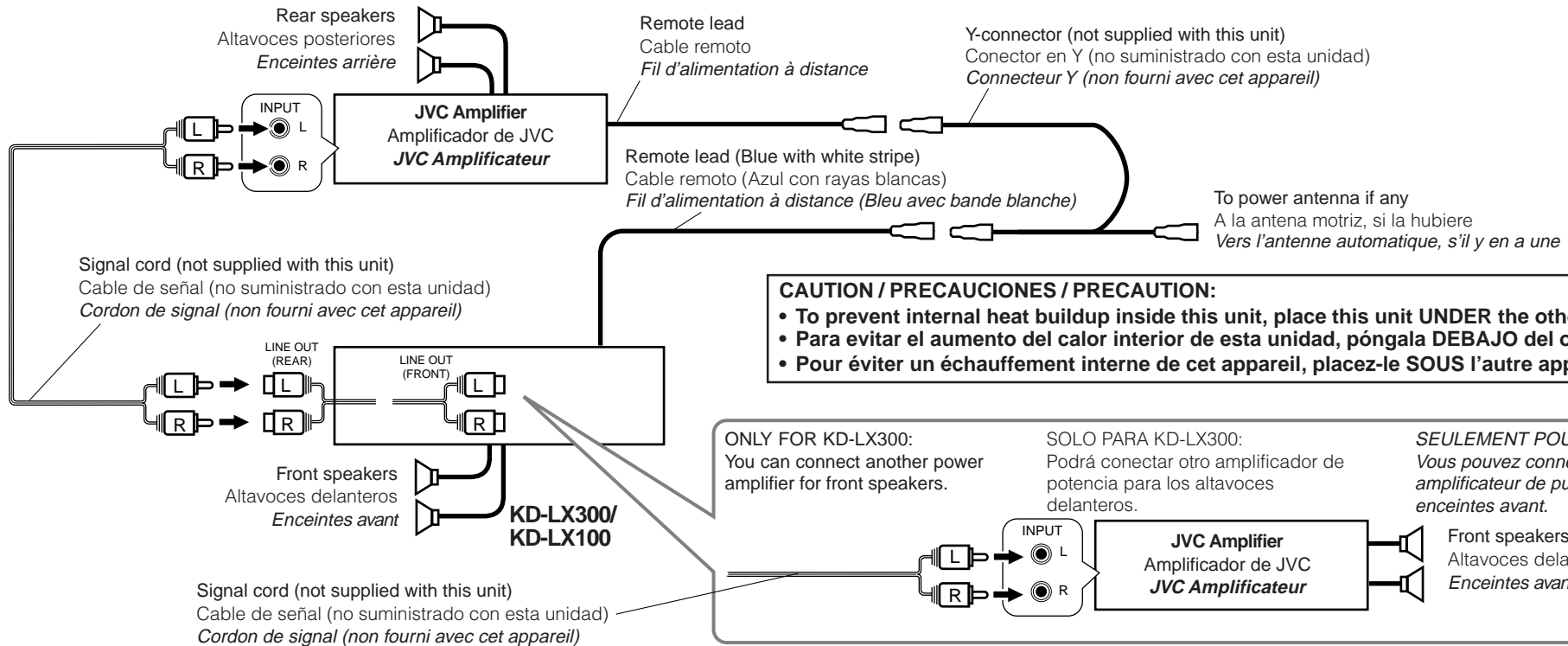

### External component / Componente exterior / Appareil extérieur

#### FOR KD-LX300/PARA KD-LX300/POUR LE KD-LX300

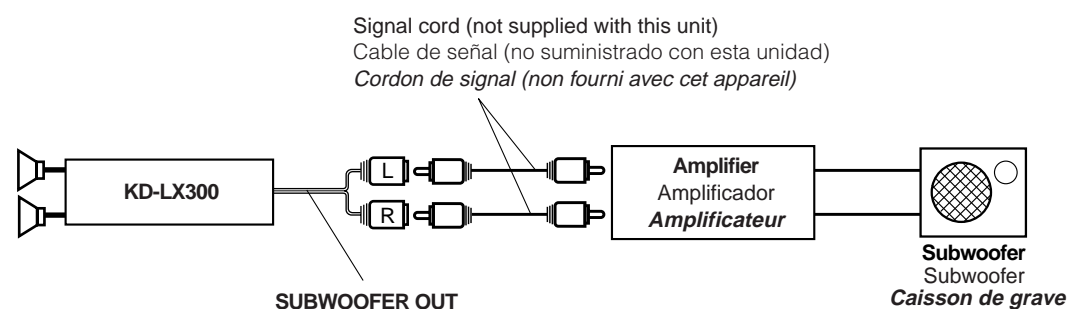
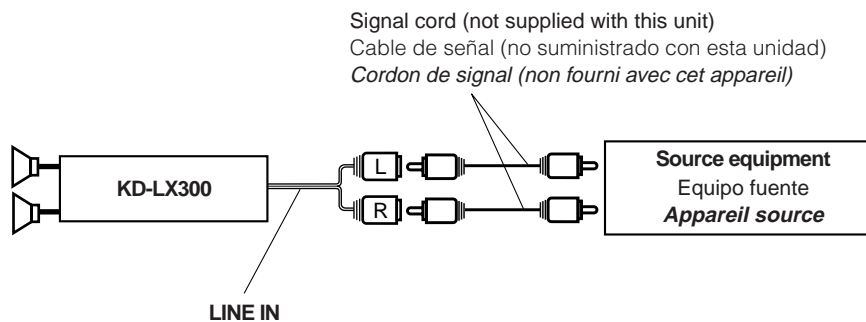

#### FOR KD-LX100/PARA KD-LX100/POUR LE KD-LX100

Line Input Adaptor KS-U57 (not supplied with this unit)  
Adaptador de entrada de línea KS-U57 (no suministrado con esta unidad)  
Adaptateur d'entrée de ligne KS-U57 (non fourni avec cet appareil)

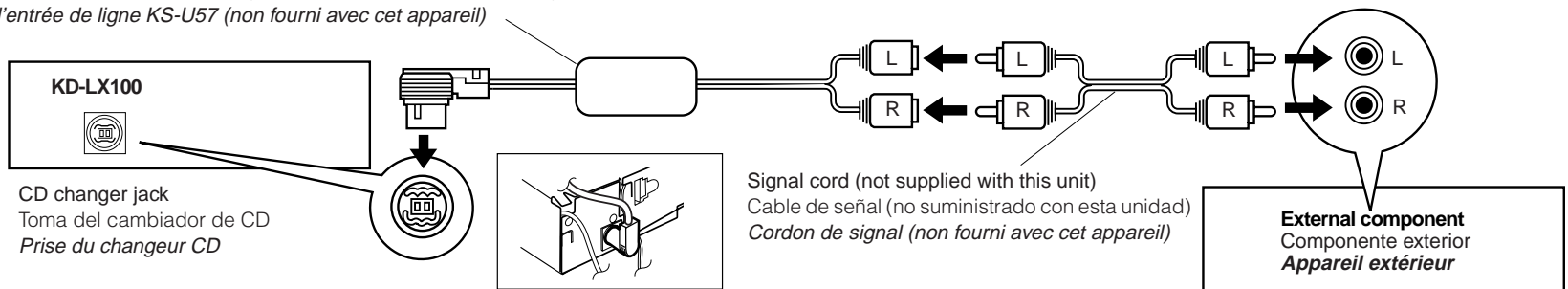

### TROUBLESHOOTING

- **The fuse blows.**
  - \* Are the red and black leads connected correctly?
- **Power cannot be turned on.**
  - \* Is the yellow lead connected?
- **No sound from the speakers.**
  - \* Is the speaker output lead short-circuited?
- **Sound is distorted.**
  - \* Is the speaker output lead grounded?
  - \* Are the “-” terminals of L and R speakers grounded in common?
- **The unit becomes hot.**
  - \* Is the speaker output lead grounded?
  - \* Are the “-” terminals of L and R speakers grounded in common?

### LOCALIZACION DE AVERIAS

- **El fusible se quema.**
  - \* ¿Están los conductores rojo y negro correctamente conectados?
- **No es posible conectar la alimentación.**
  - \* ¿Está el cable amarillo conectado?
- **No sale sonido de los altavoces.**
  - \* ¿Está el cable de salida del altavoz cortocircuitado?
- **El sonido presenta distorsión.**
  - \* ¿Está el cable de salida del altavoz conectado a masa?
  - \* ¿Están los terminales “-” de los altavoces L y R conectados a una masa común?
- **La unidad se calienta.**
  - \* ¿Está el cable de salida del altavoz conectado a masa?
  - \* ¿Están los terminales “-” de los altavoces L y R conectados a una masa común?

### EN CAS DE DIFFICULTES

- **Le fusible saute.**
  - \* Les fils rouge et noir sont-ils raccordés correctement?
- **L'appareil ne peut pas être mise sous tension.**
  - \* Le fil jaune est-elle raccordée?
- **Pas de son des enceintes.**
  - \* Le fil de sortie d'enceinte est-il court-circuité?
- **Le son est déformé.**
  - \* Le fil de sortie d'enceinte est-il à la masse?
  - \* Les bornes “-” des enceintes gauche et droit sont-elles mises ensemble à la masse?
- **L'appareil devient chaud.**
  - \* Le fil de sortie d'enceinte est-il à la masse?
  - \* Les bornes “-” des enceintes gauche et droit sont-elles mises ensemble à la masse?